

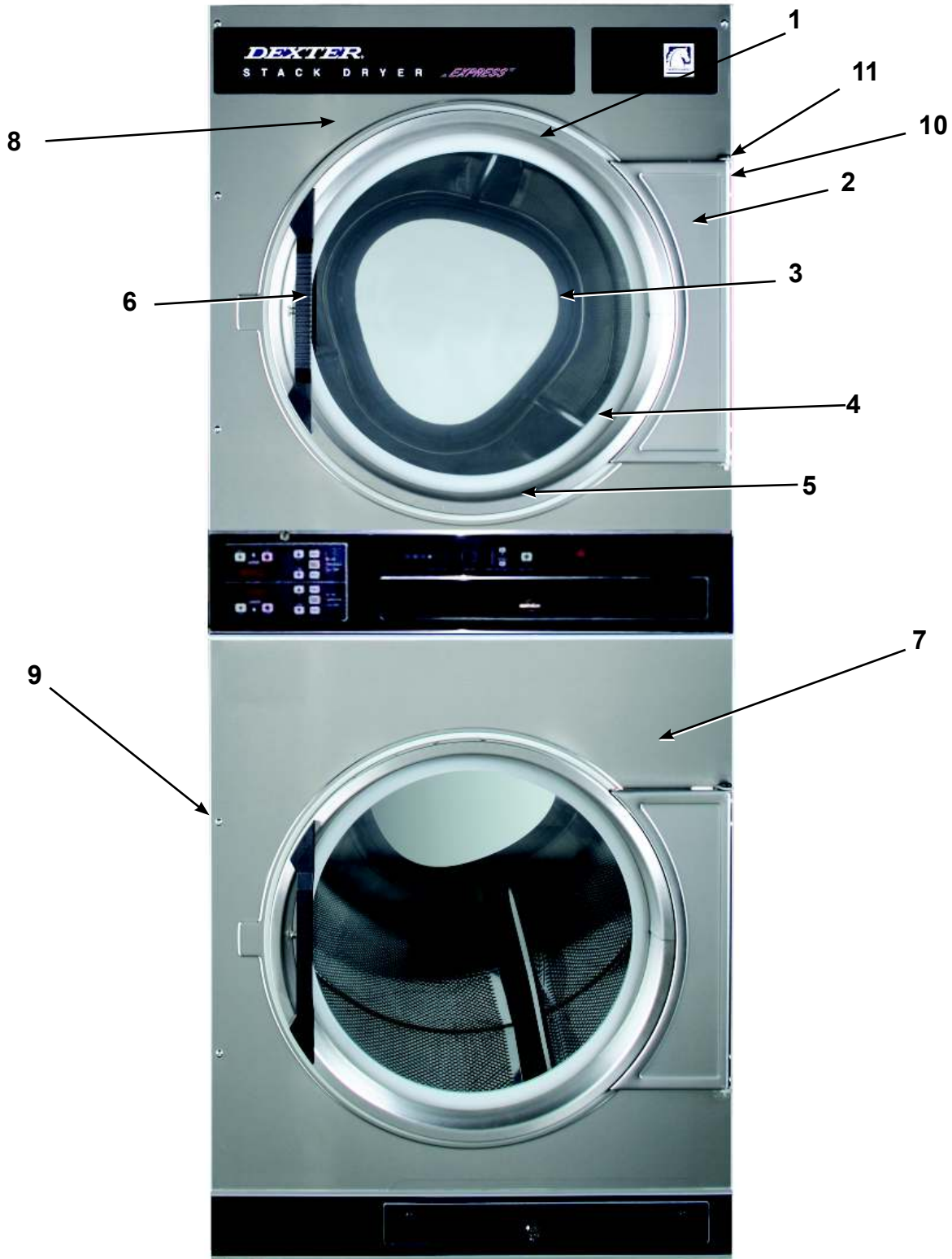

## Section 6:

Parts Data  
30# Stack



## Cabinet Group - 30lb

Key	Part Number	Description	Quantity
*	9960-256-032	Door Assy., Loading Complete-Wht .....	2
*	9960-256-034	Door Assy., Loading Complete-SS .....	2
1	9960-255-008	Door Assy., Loading-SS(ring only) .....	2
2	9982-280-014	Plate Assy., Hinge (Wht) No Pin .....	.2
2	9982-280-012	Plate Assy., Hinge (SS) No Pin.....	2
*	9545-012-015	Screw, Hinge to Door .....	8
*	8640-413-002	Nut, Hinge to Door .....	8
3	9212-002-003	Glass, Door .....	2
4	9206-413-001	Gasket, Glass (Black).....	2
*	9548-117-000	Support, Door Glass .....	.2
5	9206-420-003	Gasket, Outer Rim (Black) .....	2
6	9244-082-001	Handle, Loading Door .....	2
*	9545-018-017	Screw, Handle 1/4-20 x 3/8 .....	2
*	9531-033-001	Stud, Door Catch .....	2
*	8640-413-001	Nut, Hex .....	2
*	8640-413-003	Nut, Acorn .....	2
*	9086-015-002	Catch, Loading Door .....	.2
*	8638-190-009	Pop Rivet for mtg. catch .....	4
*	8641-582-019	Lockwasher .....	4
*	8640-399-001	Spring Nut .....	.6
7	9989-569-006	Panel Assy., Front- Lower (Wht) .....	1
7	9989-569-004	Panel Assy., Front- Lower (SS) .....	.1
8	9989-568-006	Panel Assy., Front- Upper (Wht) .....	1
8	9989-568-004	Panel Assy., Front- Upper (SS) .....	.1
9	9545-008-014	Screw, Phillips 10B x 1 3/4".....	14
9	8541-585-001	Washer finish .....	6
*	8640-399-001	Nut, Spring .....	12
10	9544-072-002	Strap, Hinge .....	.2
*	9345-008-020	Screw, Hinge to Panel .....	8
11	9545-052-001	Screw, Door to Hinge Strap (Special Black Type) .....	.2
*	8641-436-003	Washer, Fiber .....	2

## Cabinet Group - 30lb (continued)

Key	Part Number	Description	Quantity
14	9994-030-002	Escutcheon, Upper .....	1
15	9435-026-001	Trim, Overlay-Upper (Blue).....	1
15	9435-034-001	Trim, Overlay-Upper (Black) .....	1
16	9994-031-001	Escutcheon, Lower .....	1
17	9435-020-001	Trim, Overlay-Lower (Blue).....	1
17	9435-028-001	Trim, Overlay-Lower Black) .....	1
18	9412-154-001	Nameplate Stack Dryer Express (Blue).....	.1
18	9412-167-001	Nameplate Stack Dryer Express (Black) .....	.1
21	8650-026-002	Lock, Thumb Turn .....	2
22	9857-187-001	Controls Assy, Electronic Mounted With Membrane Switch (Blue). 1	1
22	9857-187-003	Controls Assy, Electronic Mounted With Membrane Switch (Black) 1	1
22	9801-096-001	Membrane Switch Assy (Blue) .....	1
22	9801-105-001	Membrane Switch Assy (Black).....	1
23	8650-012-003	Lock and Key, Control #6324 .....	1
24	9501-006-002	Sensor Temp Control.....	2
24	9486-137-002	Retainer - Push On.....	2
25	9866-004-010	Lint Drawer Assembly (Blue) .....	2
25	9866-004-013	Lint Drawer Assembly (Black).....	2
25	9435-003-009	Overlay trim, lint dwr, upper/lower (Blue) .....	1
25	9435-029-002	Overlay trim, lint dwr, upper/lower (Black).....	1
*	9545-020-009	Screw.....	10
*	9532-074-003	Felt Seal ( back of lint screen assembly ) .....	2
*	9805-029-002	Lint Screen Assembly ONLY (no front) .....	2
*	9555-057-002	Replaceable Lint Screen Only .....	.2
*	9095-044-001	Cam, Lock Lint Drawer .....	.2
*	9545-008-001	Lint Screen Strap Hold Down Screws 10Bx 1/4 .....	32
*	9627-885-001	Harness, Electronic Control .....	.1
*	9095-041-001	Cam, Lock Control.....	1
*	6292-006-007	Key 6324 only for Computer.....	2
*	9627-886-001	Harness, Heat Sensor.....	1
*	9277-041-011	Insulation Cabinet Cover .....	.1
*	9209-037-002	Grommet, 3/16 ID .....	2
*	8544-006-001	Leg, Leveling 1/2" .....	4
*	9074-261-001	Cover, Cabinet (Top).....	1
*	9732-102-011	LP Kit for DDAD Dryers.....	1
*	9732-243-001	Stack Dryer Trunion Puller .....	1
*	9555-057-003	Replaceable Lint Screen Fine Mesh Only .....	.1
*	9277-063-001	Insulation-Front Panel-Top Half .....	2
*	9277-063-002	Insulation-Front Panel-Lower Half.....	2
*	8640-276-002	Wire Nut Connector Grey.....	4
*	9527-007-002	Standoff Wire Saddle.....	8
*	9544-041-002	Strap - Bead Tie.....	1

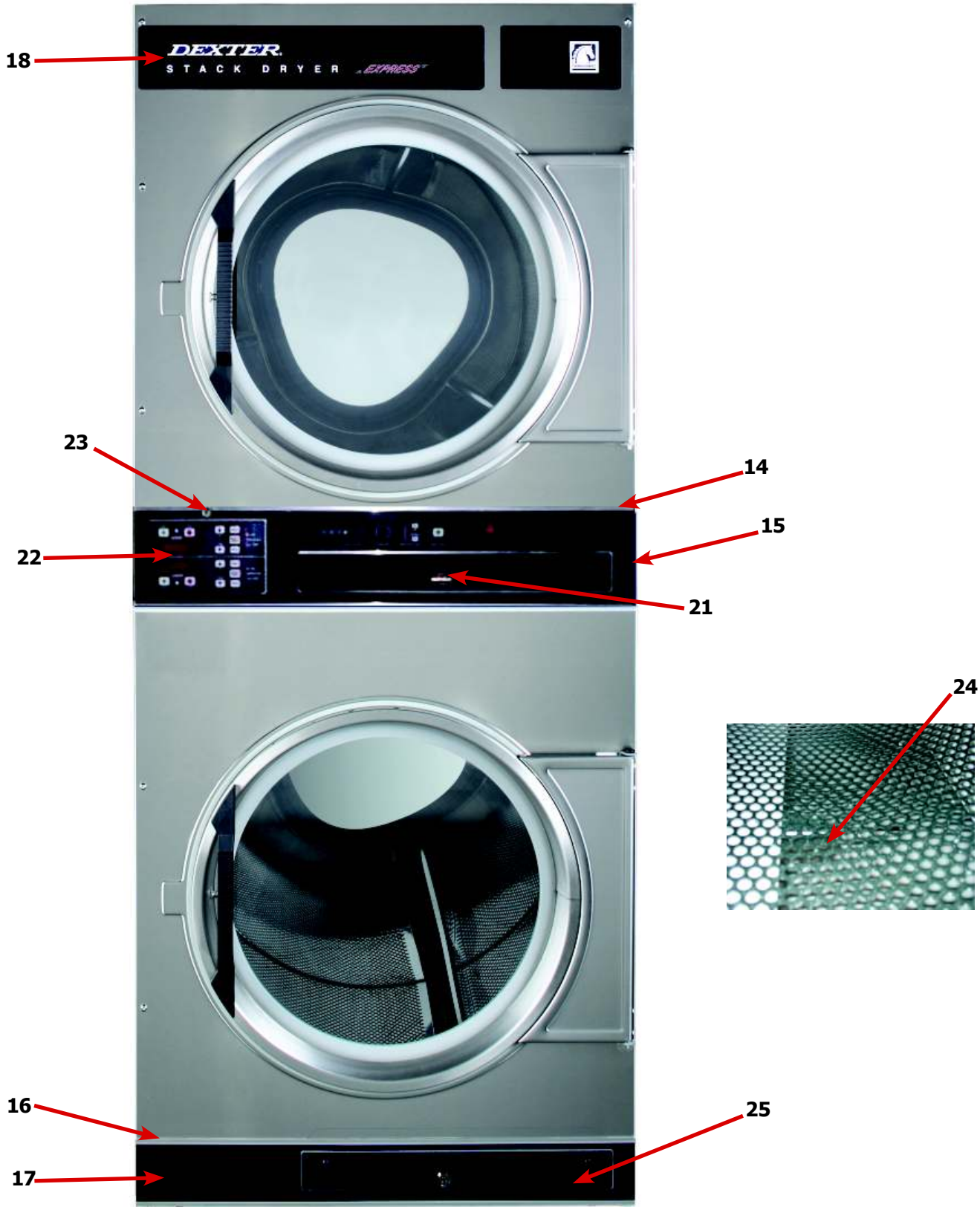

---

# Door Switch Group - 30lb

**Part Number**  
9539-487-001

**Description**  
Door Switches .....2

**Quantity**



---

# Hinge Plate Cover

1	9074-341-002	Cover-Hinge, Black.....	2
2	8636-018-001	Screw-TRHDCR, 10B x 3/8, Black.....	4

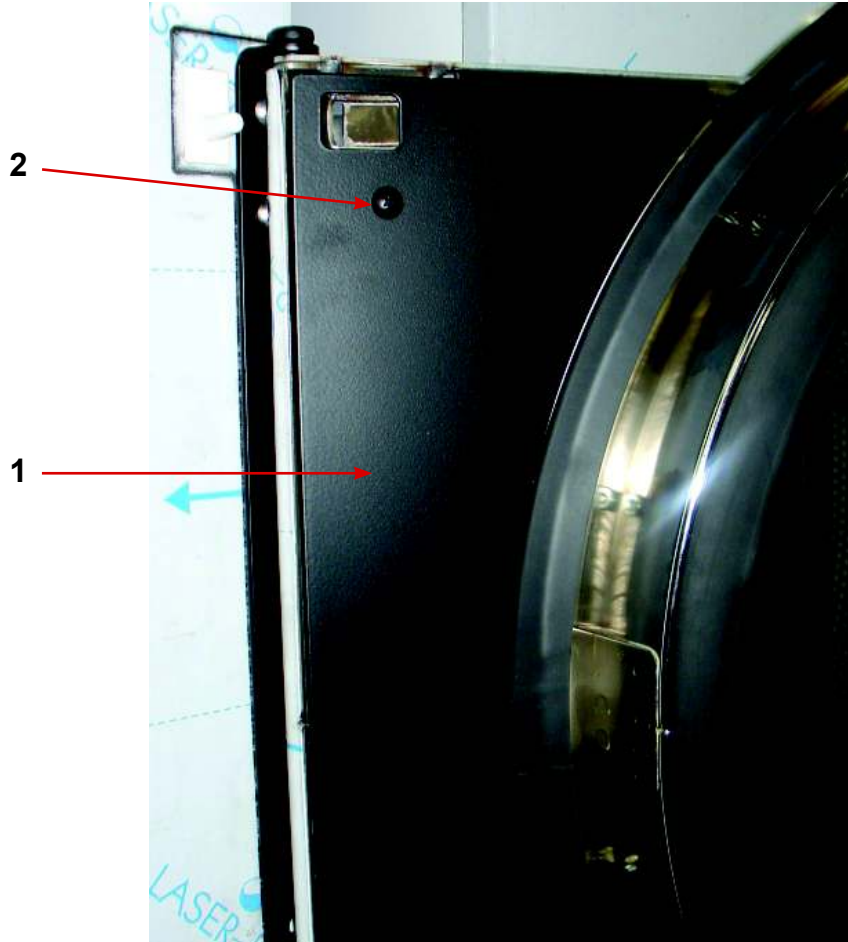

# Bearing Housing Group

Key	Part Number	Description	Quantity
*	9803-160-003	Bearing Housing Complete Assy (Includes bearings & Spacer).....	1
1	9241-161-002	Housing, Bearing.....	1
*	9036-130-001	Bearing, Ball, Front .....	1
*	9538-139-002	Spacer, Bearing .....	1
2	9036-130-001	Bearing, Ball, Rear .....	1
3	9545-049-002	Screw-Wizlock, 3/8-24x3/4 .....	4
4	8640-400-002	Nut, 5/16-18.....	4
5	9545-049-001	Screw, 3/8-24x1.....	2
6	8640-415-002	Nut, 3/8-24.....	2
*	9538-139-002	Shim, Tumbler .....	AR

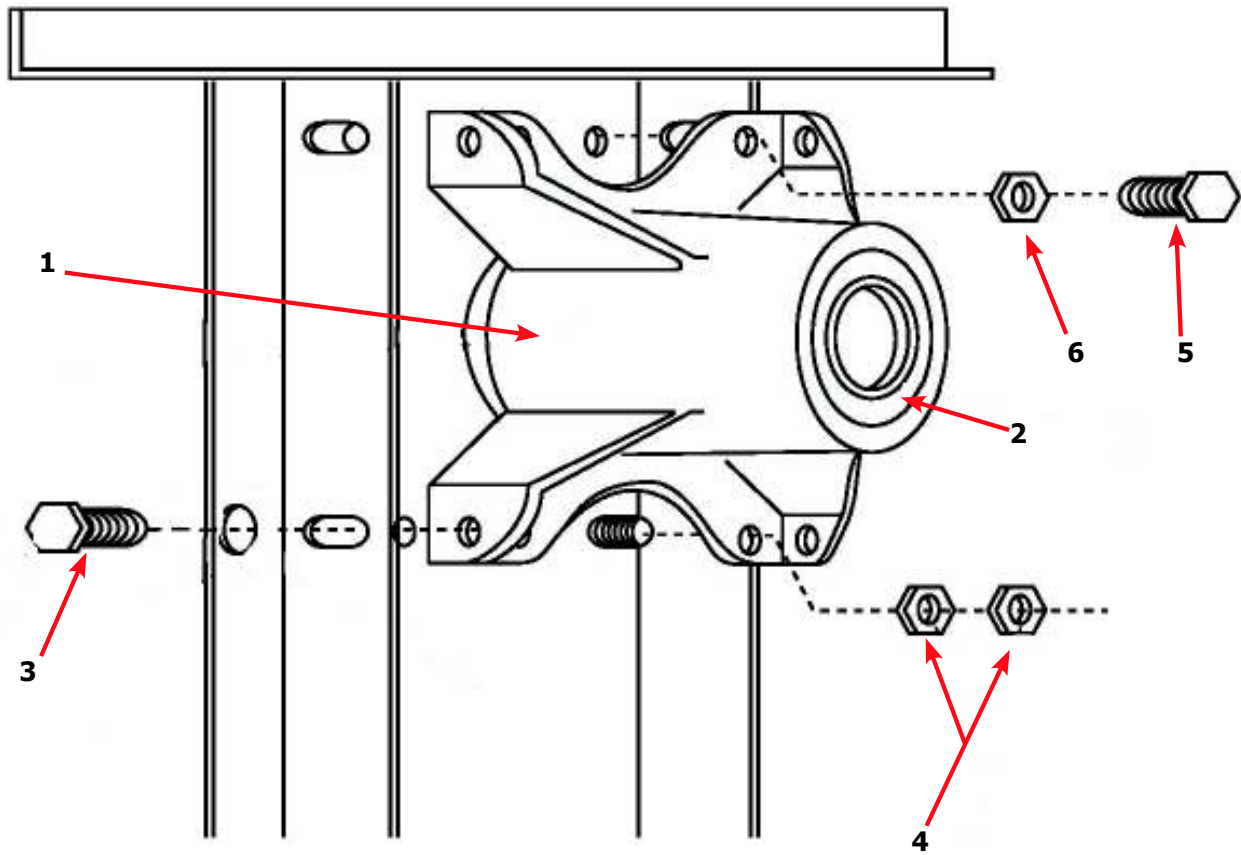



# Tumbler Group

Key	Part Number	Description	Quantity
*	9848-147-001	Tumbler Assy Complete W/Spider (GALV).....	1
*	9848-147-002	Tumbler Assy Complete W/Spider (SS & Galv front) .....	1
1	9848-146-001	Tumbler Assy (Galvanized).....	1
1	9848-146-002	Tumbler Assy (Stainless Galvanized front).....	1
2	9497-019-003	Rod, Tumbler .....	3
3	8641-554-001	Washer, Special.....	3
4	9552-013-000	Shim .....	AR
5	9568-015-001	Spider Assy.....	1
6	8640-415-004	Nut, Wiz Lock .....	3
7	9538-164-001	Spacer-Shaft.....	1
8	9487-234-005	Tolerance Ring .....	1
9	9908-049-002	Pulley, Driven.....	1
10	8641-581-026	Washer -Flat.....	1
11	8641-582-016	LockWasher - IntTooth, 1".....	1
12	9545-017-009	Screw, 1/2-13x1 1/4.....	1

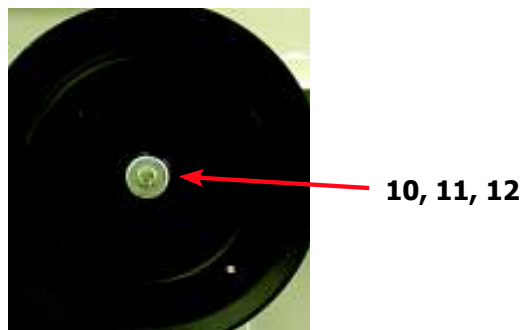
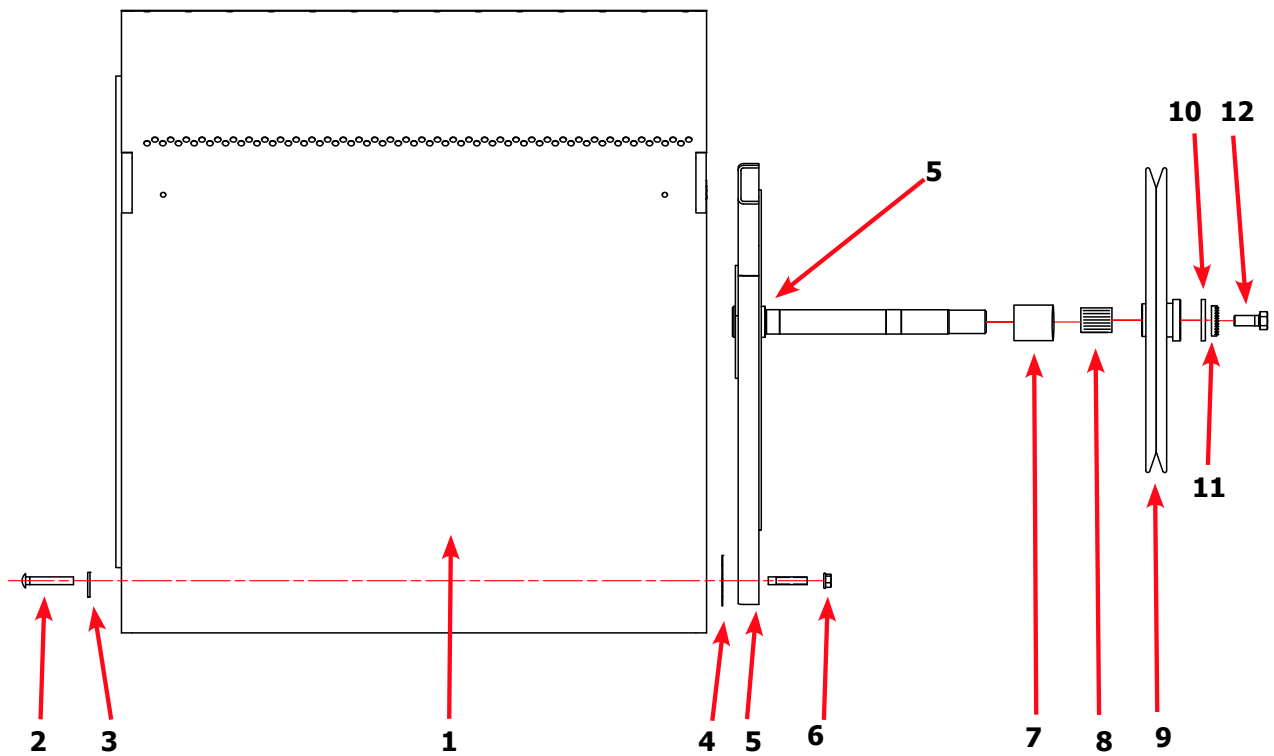

# Burner Housing Group - 30lb

Key	Part Number	Description	Quantity
1a	9452-730-001	Service Burner Plate Front... ..	2
1	9452-729-001	Service Plate baffle Recirculation Chamber Clean Out .....	2
2	9545-008-001	Screw .....	16
18	9003-220-001	Angle, Burner Support .....	2
17	9048-020-001	Burner, Main .....	4
4	9545-008-001	Screw 10B x1/4" .....	.8
5	9875-002-003	Electrode Assy, Ignition .....	2
19	9545-045-001	Screw, Electrode Mtg 8B x 1/4" .....	4
7	9379-186-001	Valve, Gas Shut Off .....	1
8	9857-134-001	Control Assy, Gas .....	2
9	9381-012-001	Manifold, Assy 2 Part 1 Piece .....	2
22	8615-104-038	Pipe Plug in end of Burner Manifold .....	2
11	9452-749-001	Plate Assy, Hi-Limit Stat Ignitor .....	2
12	9576-203-002	Thermostat, Hi-Limit .....	2
13	9074-315-001	Cover, Hi-Limit Stat Ignitor .....	2
15	9825-058-001	Cover, Safety Stat .....	2
16	9857-116-003	Control, Ignition Fenwall (3 trybox) .....	2
*	9803-199-001	Housing Assembly, Burner .....	.2
*	9545-008-006	Screw 10AB x 3/8" .....	4
*	9454-816-001	Panel, Back Burner Housing.....	2
*	9425-069-023	Orifice, Burner-Natural #125 .....	4
*	9425-069-024	Orifice, Burner-LP #49.....	4
*	9039-915-001	Bracket, Gas Control .....	2
*	9545-008-006	Screw .....	.4
*	9538-142-001	Spacer, Hi-Limit .....	4
*	9545-045-007	Screw 8B x 3/4" .....	4
*	9545-008-006	Screw .....	6
*	9576-207-008	Thermostat, Safety Shutoff .....	2
*	9545-008-006	Screw .....	4
*	9545-008-006	Screw .....	4
*	9550-173-001	Shield, Burner Inlet .....	.1
*	9732-102-011	Kit, LP Conversion DDAD Kit .....	.2

^ Models built before 9/07

# Burner Housing Group Photos - 30lb

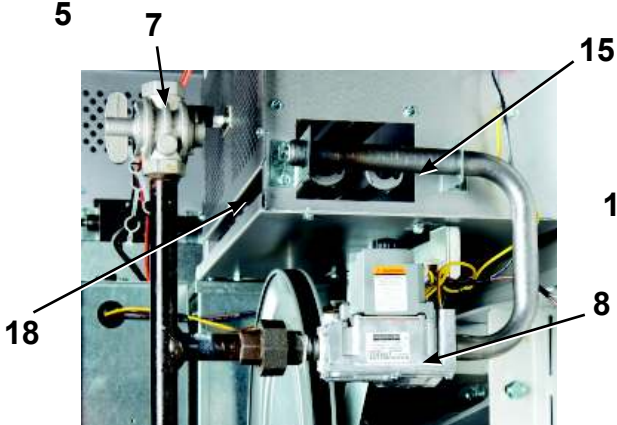
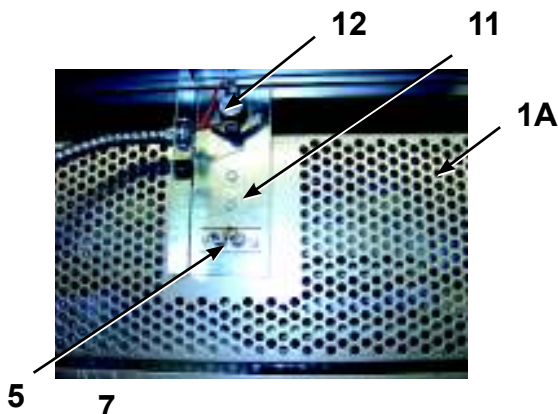
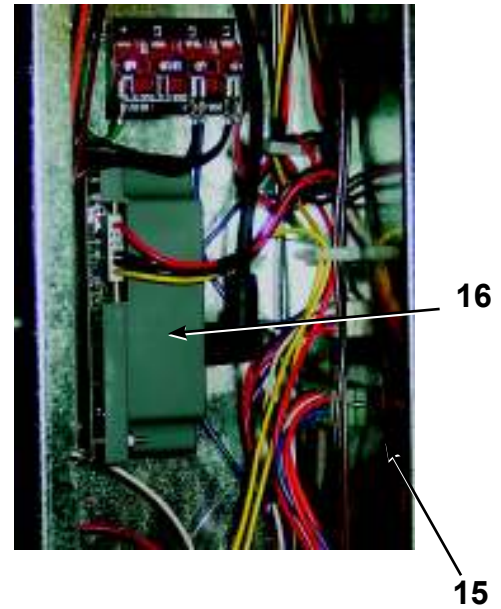
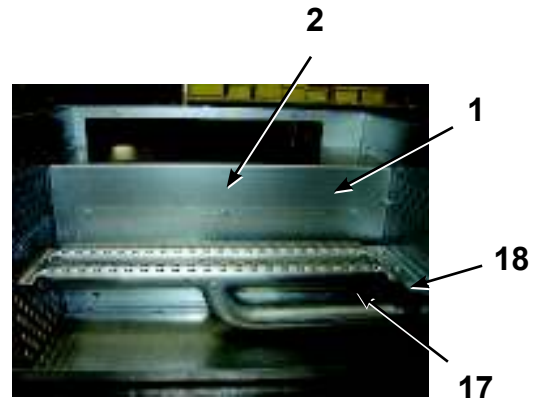
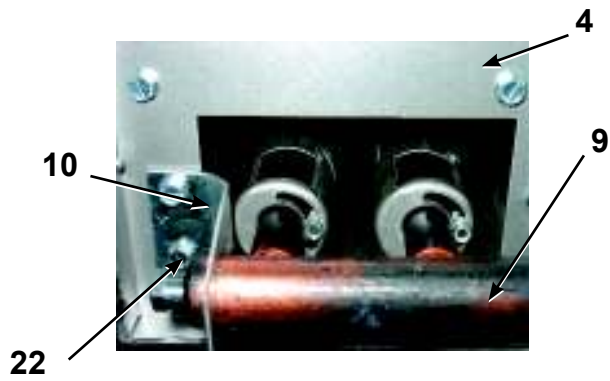

## Rear View - 30lb

Key	Part Number	Description	Quantity
*	9627-861-001	Wire Harness Overtemperature Switch.....	2
*	9801-095-001	Switch Assy, Air Flow .....	2
1	9539-461-009	Switch, Air Flow.....	2
2	9029-174-001	Bracket, Switch- Air Flow .....	2
3	9008-007-001	Actuator, Switch .....	2
4	9451-169-002	Pin, Cotter .....	2
5	9545-020-001	Screw 4-40 x 5/8" .....	4
*	8640-401-001	Nut, Special Twin #4-40.....	2
*	9550-169-003	Shield, Switch.....	2
*	9545-008-001	Screw 10 Bx 1/4".....	6
7	9376-331-001	Motor, Drive 5hp .....	2
*	9732-202-026	Motor, Drive Kit.....	2
8	9452-740-001	Plate, Motor Mtg.....	2
*	9545-029-008	Bolt 3/8" - 16 x 3/4".....	8
*	8641-582-003	Lockwash Spring 3/8 .....	8
9	9545-018-019	Screw, Motor Plate to Back Assy. 1/4-20x 2 1/2 .....	8
9	86411-582-007	Lockwasher 1/4.....	8
9	9538-163-006	Spacer .....	8
9	8641-581-017	Flat Washer 1/4 x 7/8.....	24
9	9209-086-002	Rubber Grommet.....	8
*	9538-166-006	Grommet Spacers.....	8
*	9545-028-013	Screw, Set .....	4
10	9962-017-002	Back Assy, Blower Hsg.....	2
26	9278-039-001	Impeller, W/Set Screws.....	2
11	9991-053-001	Support Assy, Intermed. Pulley .....	2
12	9545-029-010	Bolt, Rd Hd 3/8-16 x 1 1/4.....	6
13	9545-029-003	Bolt, 3/8-16 x 1 1/2.....	2
12	8640-415-004	Nut Flange Wiziocok 3/8" - 16 .....	6
12	8641-581-035	Washer, Flat.....	6
14	9861-022-001	Arm Assy-Tension, Complete .....	2
*	8641-581-035	Washer, Flat.....	2
15	9487-200-003	Ring-Retaining .....	6
16	9908-039-004	Pulley Assy, Intermediate with bronze flange bearing.....	2
*	9036-145-002	Bearing - Bronze Flange.....	4
17	9908-040-001	Pulley Driven.....	2
*	9306-006-000	Key Tumbler Shaft Woodcuff .....	2
*	8640-222-000	Nut Hex 1" - 14 .....	2
*	8641-582-015	Washer Lock .....	2
*	9538-164-001	Spacer, Shaft .....	2
18	86A1-582-015	Washer, Lock .....	2
19	9040-077-001	Belt, Drive- Motor.....	2
20	9040-073-009	Belt, Drive- Tumbler .....	2
21	9534-319-002	Spring, Tension .....	2
22	9099-012-002	Chain, Tension.....	2
23	9248-022-002	Hook, Tension.....	2
*	9125-007-001	Damper Inside Duct Exhaust Upper .....	1
24	9451-146-001	Pin, Damper Hinge .....	2
*	8520-141-000	Nut, Spring .....	4
*	9425-007-002	Damper, Inside Duct Exhaust Lower .....	1
*	9545-008-026	Screw #10B x 1/2.....	6
25	9074-363-001	Cover Duct Upper.....	1
*	9074-364-001	Cover Duct Lower.....	1
*	9545-008-026	Screw 10ABx 1/2".....	14
25	9973-033-001	Heat Recirculation Assembly Duct.....	2
27	9453-157-001	Motor Pulley - Driver.....	1
*	9029-173-001	Bracket for Wire Harness Under Burner Housing.....	2
*	9545-008-024	Screw 10 AB x 3/8 .....	58

# Rear View Photos - 30lb

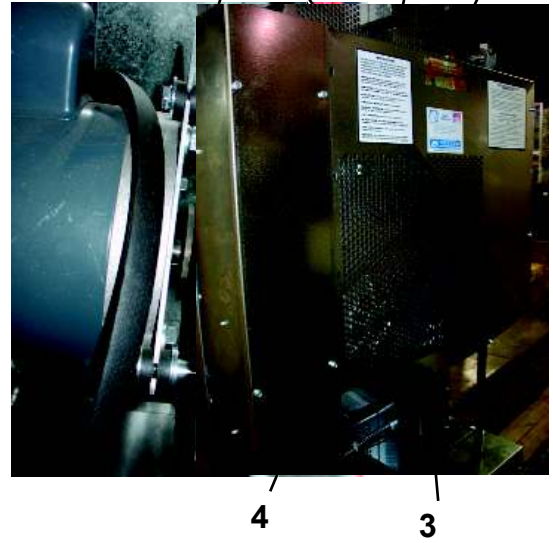
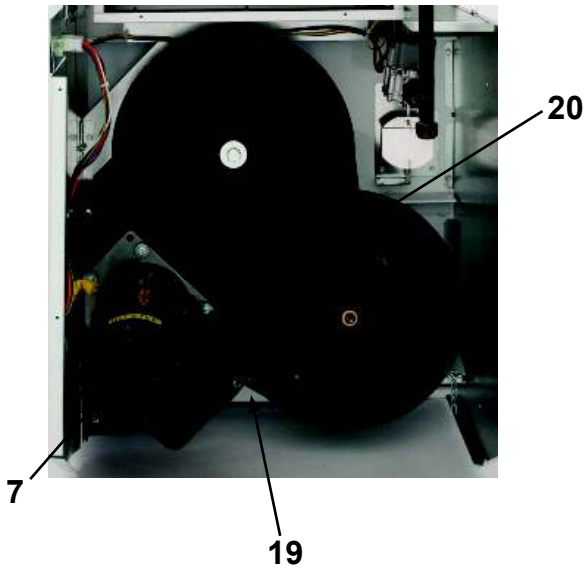
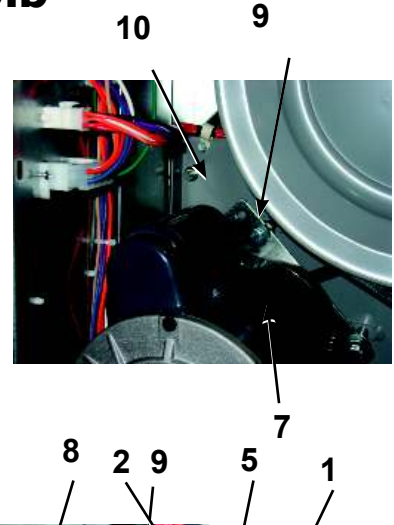
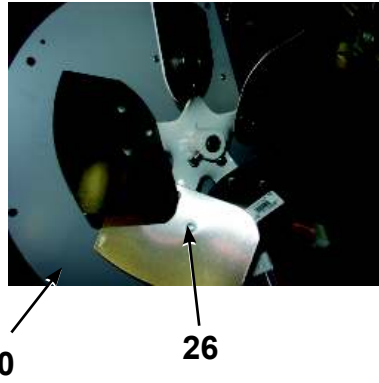
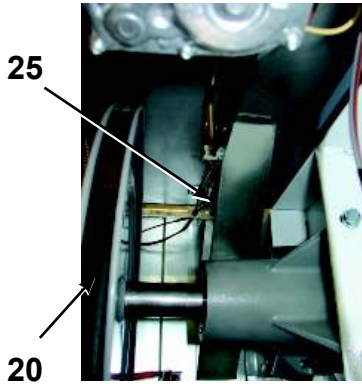

# Rear Panel & Cover Group - 30lb

Key	Part Number	Description	Quantity
1	9208-083-001	Back Drive Guard Panel .....	2
2	9208-076-001	Back Side Guard Panel Ass'y .....	2
3	9074-365-001	Cabinet (TOP COVER) .....	1
*	8544-006-001	Legs Leveling.....	4
5	9545-008-024	Screws 10 AB x 3/8 .....	4
6	9577-062-001	Top Duct w/ Oval.....	1
4	9108-117-001	Electric Box Cover w/ Hinge.....	1
*	9545-008-024	Screws, Electronic Box Cover .....	3

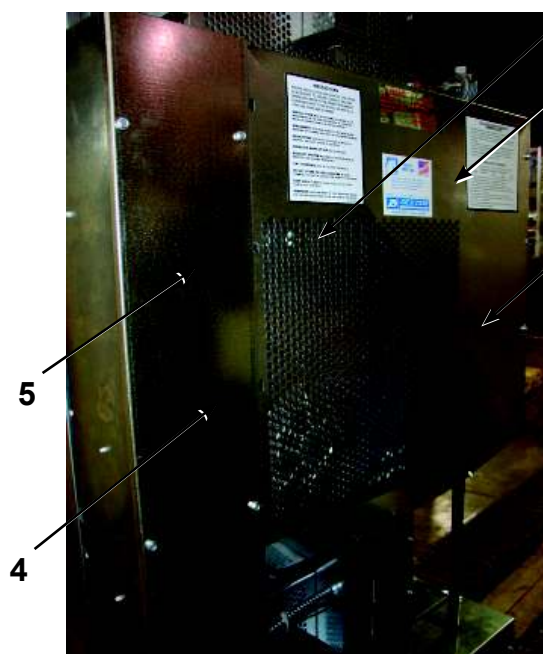
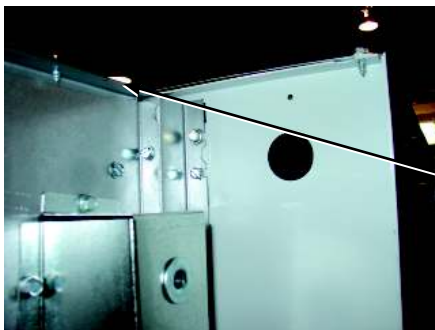

Screws

# OPL Control Board - 30lb

Key	Part Number	Description	Quantity
1	9857-187-001	Control Assembly (Blue) .....	1
1	9857-187-003	Control Assembly (Black) .....	1
2	9471-017-001	PCB Control Board .....	1
3	9471-018-001	PCB Display Board .....	1
4	9500-007-001	Cable, Upper Control Long .....	1
5	9500-007-002	Cable, Lower Control Long .....	1
6	9801-096-001	Membrane Switch Assembly (Blue) .....	1
6	9412-167-001	Membrane Switch Assembly (Black) .....	1
7	8636-024-001	Fuse, 600ma / 250v .....	2
*	9627-885-001	Harness Main Control OPL Stack Dryer .....	1

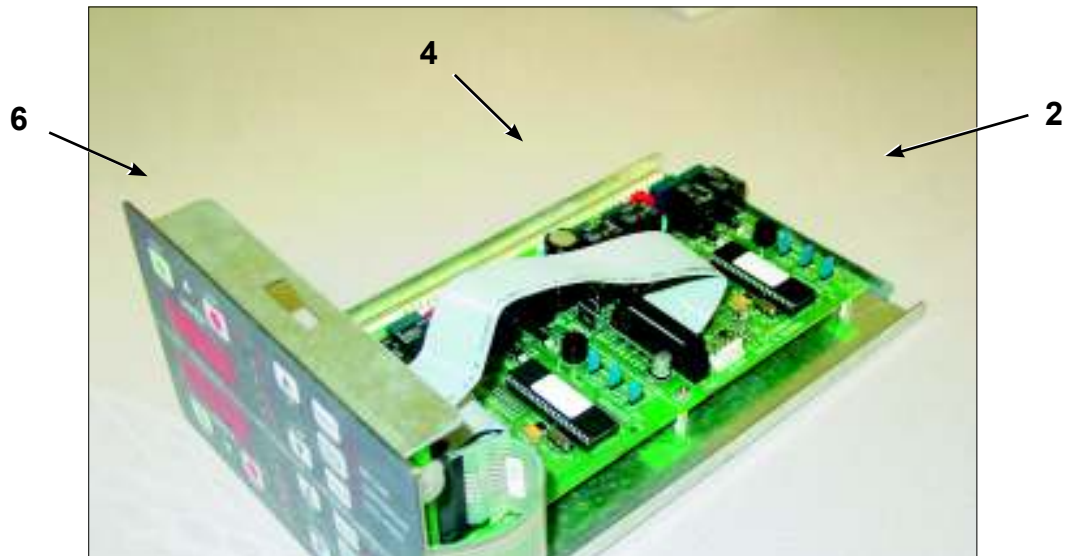
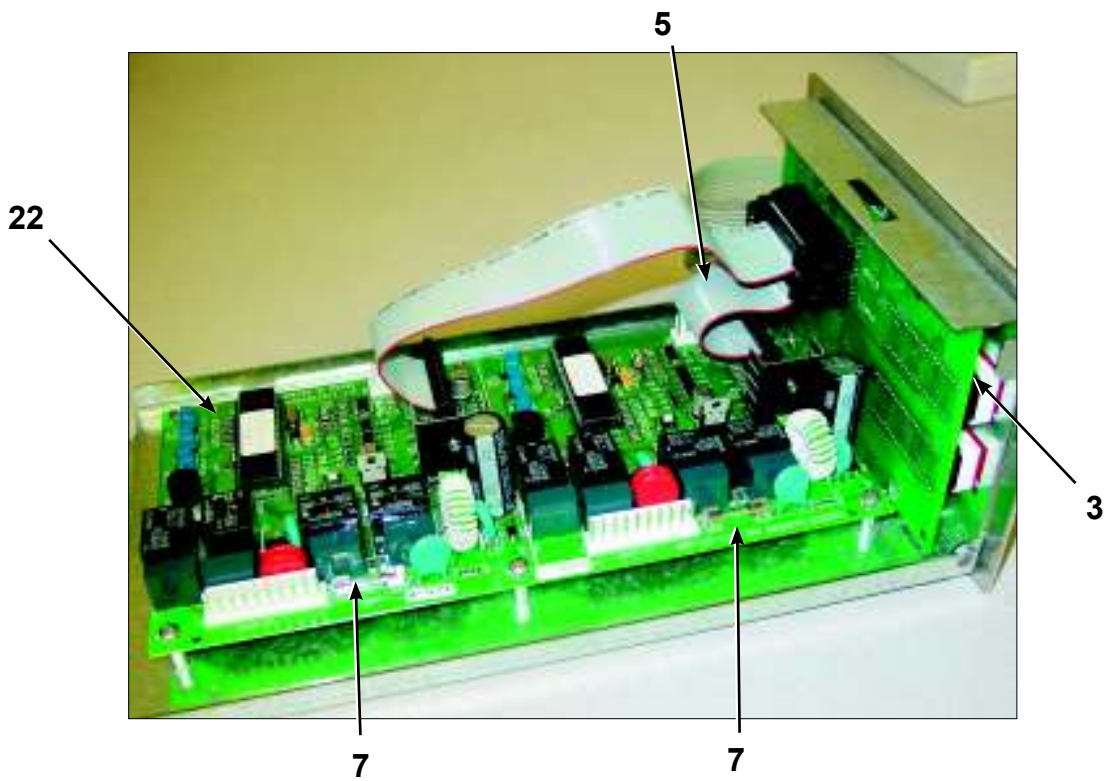

# Control Assembly Group

Key	Part Number	Description	Quantity
*	9857-187-003	Control Assmby Complete (all below included) .....	1
*	9074-317-001	Control Box Cover .....	1
1	8653-068-003	Connector Conduit 3/8" STR.....	1
2	9558-029-003	Strip Terminal Marker (Behind Input Power) to above #3 .....	1
3	9897-035-001	Terminal Block Assembly Main Power Inlet .....	1
*	9545-008-024	Screws 10AB x 3/8" .....	4
*	9627-859-003	Wire Harness - Power Main .....	1
4	8220-001-478	Wire Assembly Green 7" .....	1
5	9545-008-027	Screw # 10-32 x 12 Green .....	1
*	8641-582-006	Lockwasher Ext Tooth #10.....	1
6	9897-026-002	Terminal Block Main Power Middle .....	1
7	9897-026-001	Terminal Block.....	2
*	9545-045-012	Screw #8 ABx1 2 for terminal block.....	6
8	8711-013-001	Transformer Control.....	1
*	9545-008-024	Screws 10AB x 3/8" .....	4
9	9857-182-001	Ignition Control .....	2
*	9545-008-018	Screws 10AB x 3/4" .....	4
10	9631-403-009	Wire Assembly High Voltage Upper .....	1
11	9627-867-005	Wire Harness Ignition Control Upper .....	1
12	9631-403-008	Wire Assembly High Voltage Lower .....	1
13	9627-867-006	Wire Harness Ignition Control Lower .....	1
*	9053-067-002	Bushing Wire 7/8".....	4
14	9200-001-002	Fuseholder Assembly .....	3
*	8636-018-001	Fuse 1.5 Amp.....	2
*	8636-018-004	Fuee 2.5 Amp.....	1
15	5192-299-001	Relay Power .....	2
*	9545-045-012	Screws Power #8 AB x 1/2".....	4
*	8220-062-036	Wire Assembly Red/Black 14" .....	1
*	8220-062-037	Wire Assembly Red/White 14" .....	1
16	9627-864-006	Wire Harness Motor Extension.....	2
17	9527-007-001	Stand Off - Wire Saddle / Arrowhead .....	5
18	9627-863-001	Wire Harness Main Extension Access Under Burner Housing .....	4

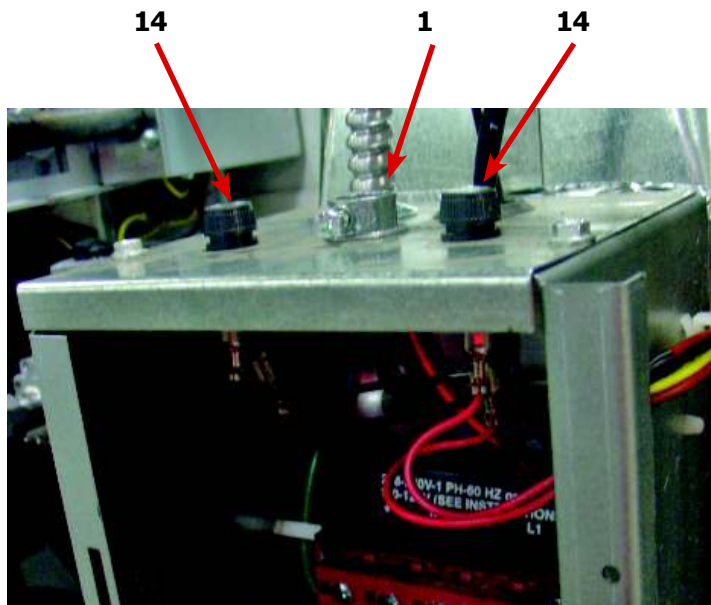



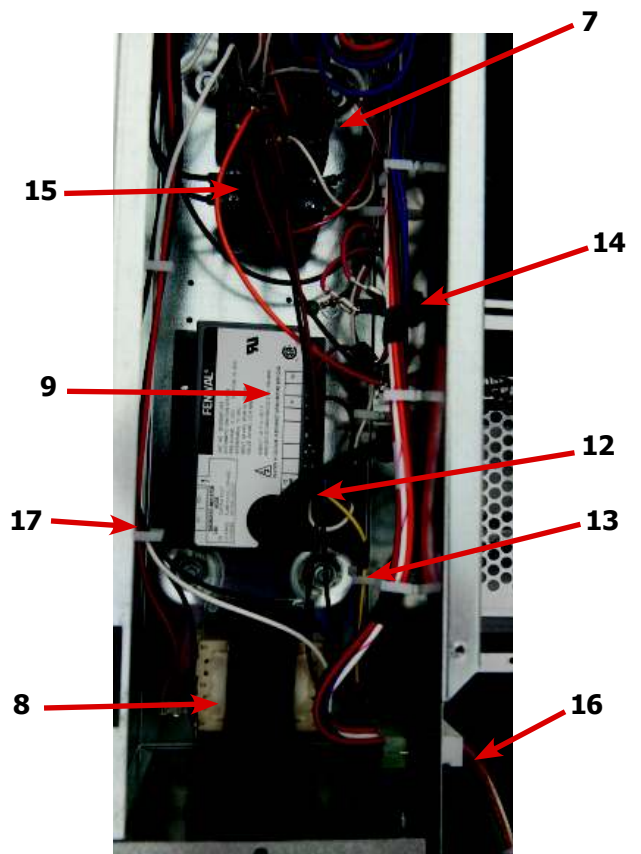
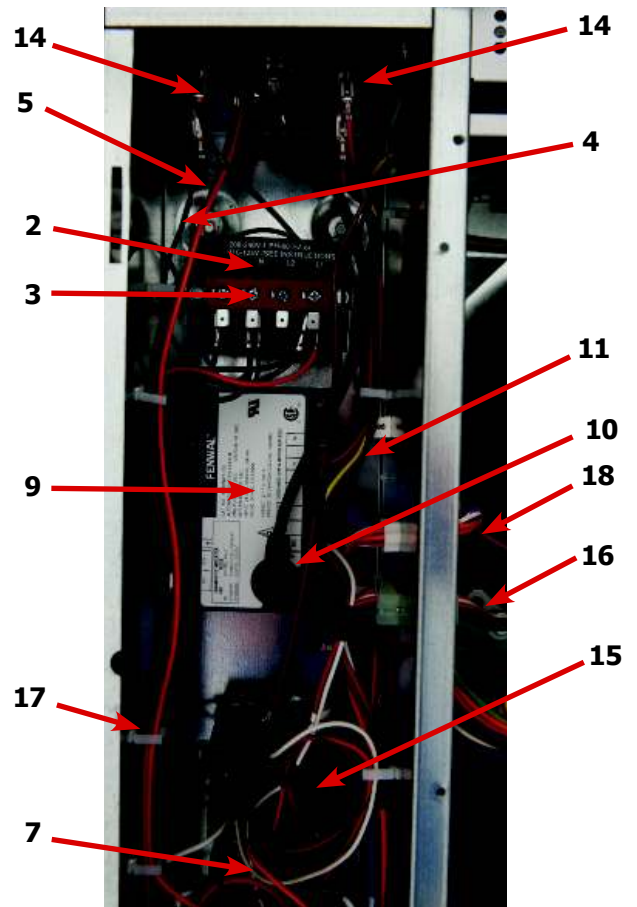
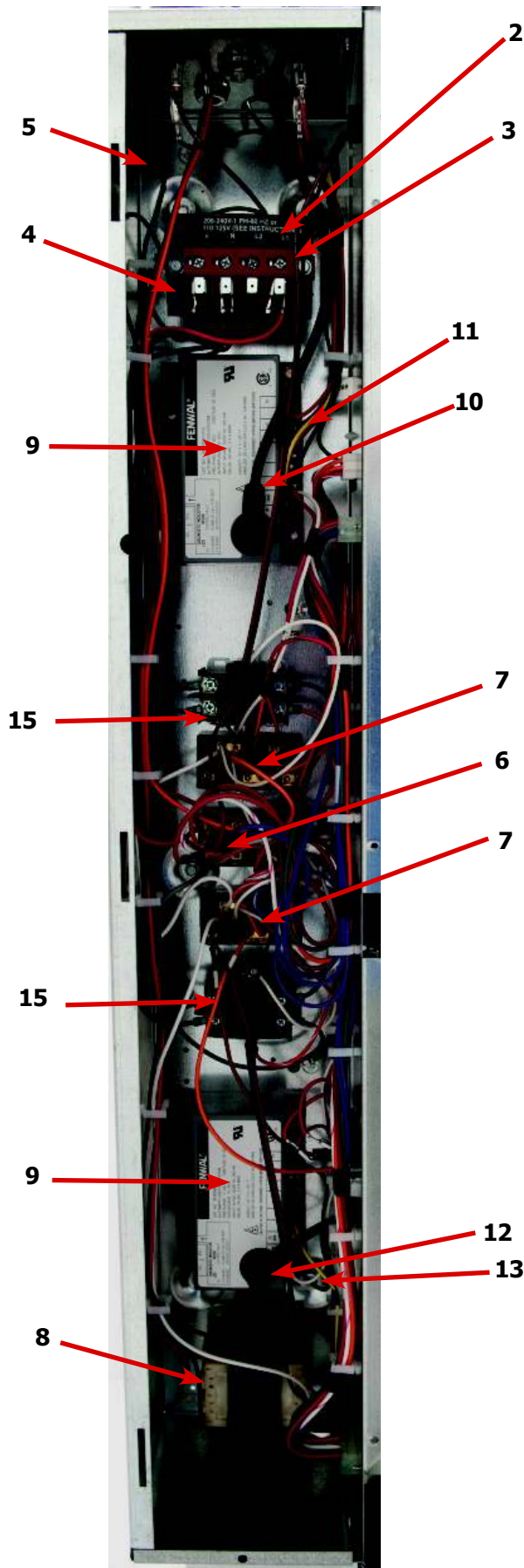

# Wiring Group - 30lb

Key	Part Number	Description	Quantity
*	9627-859-003	Wiring Harness- Main Power .....	1
*	9631-403-008	Wire, Hi Voltage, Spark 18 1/2" Lower .....	1
*	9631-403-009	Wire High Voltage, Spark 29 1/4" Upper .....	1
*	8502-645-001	Label Instruction.....	1
*	9506-353-001	Wiring Label Schematic/Diagram.....	1
*	9627-867-005	Wire Harness Ignition Upper Low Voltage .....	1
*	9627-867-006	Wire Harness Ignition Lower Low Voltage .....	1
*	9627-887-001	Wire Harness Main Extension.....	1
*	9627-864-006	Wire Harness Motor Extention .....	2
*	8220-062-036	Wire Assembly Red/Black 14".....	1
*	8220-062-037	Wire Assembly Red/White 14".....	1
*	8220-062-038	Wire Assembly White 14".....	2
*	9627-861-001	Wire Harness - Overtemp / Airswitch .....	2
*	9627-885-001	Wire Harness Main Controller .....	1
*	9627-866-001	Wire Harness - Heat Sensor .....	1
*	8527-112-001	Decal Lighting and Clearance.....	1
*	8502-600-001	Label Warning & Notice.....	2
*	9506-651-001	Schematic Label .....	1
*	8514-259-001	Owners Manual.....	1
*	8507-330-001	Instruction Transient Voltage Suppressor .....	1
*	8507-350-001	Instructions Dryer Install / Start .....	1
*	8220-137-001	Wire Assembly Green 24" .....	1
*	8220-001-466	Wire Assembly Yellow 4 7/8" Gas Valve .....	2
*	8220-095-038	Wire Assembly Orange 48".....	2
*	9506-651-001	Wiring Diagram.....	1
*	8220-095-040	Wire Assembly Orange 24" .....	1
*	8220-095-041	Wire Assembly Brown 24".....	1
*	9053-067-002	Bushings Wire 7/8".....	7
*	8220-095-039	Wire Assembly Brown 48" .....	1
*	9897-026-001	Terminal Block.....	2
*	9897-026-002	Terminal Block.....	2
*	9200-001-002	Fuse Holder.....	2
*	8636-018-001	Fuse 1.5 A.....	2
*	5192-298-002	Relay, Power 24 VAC .....	2
*	9897-035-001	Terminal Block Power 4 Pole .....	1
*	9558-029-003	Strip Marker, Terminal .....	1



# Section 7:

Parts Data  
50# Stack

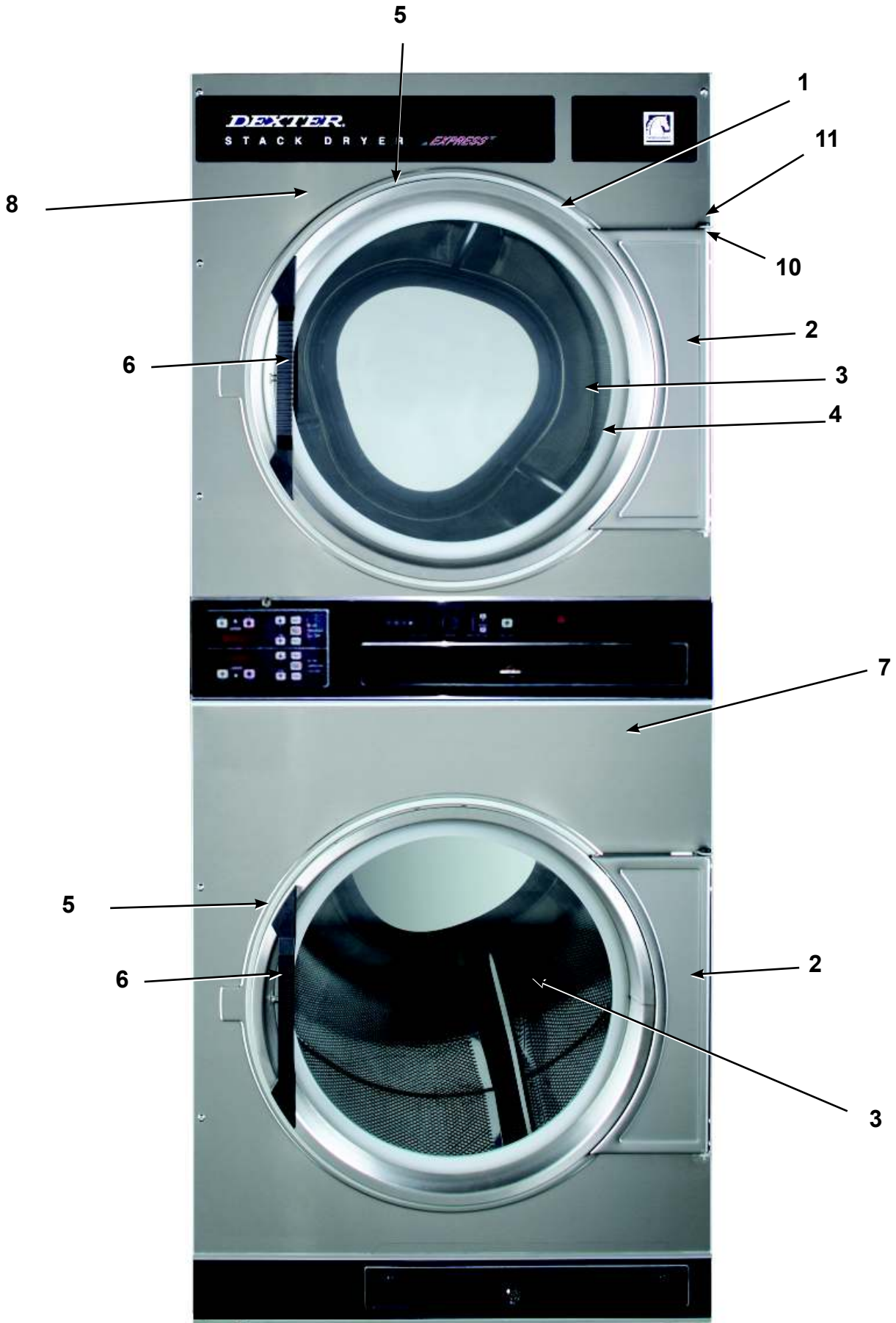

## Cabinet Group - 50lb

Key	Part Number	Description	Quantity
*	9960-285-002	Door Assy., Loading Complete-Wht .....	2
*	9960-285-001	Door Assy., Loading Complete-SS .....	2
1	9960-284-002	Door Assy., Loading-SS(ring only) .....	2
2	9982-353-002	Plate Assy., Hinge (Wht) No Pin .....	2
2	9982-353-001	Plate Assy., Hinge (SS) No Pin.....	2
*	9545-012-015	Screw, Hinge to Door .....	8
*	8640-413-002	Nut, Hinge to Door .....	8
3	9212-002-004	Glass, Door .....	2
4	9206-164-010	Gasket, Glass (Gray).....	2
4	9206-413-002	Gasket, Glass (Black).....	2
*	9548-117-000	Support, Door Glass .....	2
5	9206-420-004	Gasket, Outer Rim (Gray) .....	2
5	9206-420-005	Gasket, Outer Rim (Black) .....	2
6	9244-082-001	Handle, Loading Door .....	2
*	9545-018-017	Screw, Handle 1/4-20 x 3/8 .....	2
*	9531-033-001	Stud, Door Catch .....	2
*	8640-413-001	Nut, Hex .....	2
*	8640-413-003	Nut, Acorn .....	2
*	9086-015-002	Catch, Loading Door .....	2
*	8638-190-009	Pop Rivet for mtg. catch .....	4
*	8641-582-006	Lockwasher .....	4
*	8640-399-001	Spring Nut .....	6
7	9989-517-011	Panel Assy., Front- Lower (Wht) .....	1
7	9989-517-009	Panel Assy., Front- Lower (SS) .....	1
8	9989-517-015	Panel Assy., Front- Upper (Wht) .....	1
8	9989-517-013	Panel Assy., Front- Upper (SS) .....	1
*	9277-054-001	Insulation Front Panel, half moon (top).....	2
*	9277-054-002	Insulation Front Panel, half moon (bottom).....	2
*	9545-008-014	Screw, FLHDCR, 10B x 1.....	14
*	8641-582-019	Lockwasher .....	8
*	8640-399-001	Nut, Spring .....	12
10	9544-069-002	Strap, Hinge (Wht) .....	2
10	9544-069-004	Strap, Hinge (SS/Gray) .....	2
*	9545-012-028	Screw, Hinge to Panel .....	8
11	9545-052-001	Screw, Door to Hinge Strap (Special Black Type) .....	2
*	8641-436-003	Washer, Fiber .....	2

## Cabinet Group - 50lb (Continued)

Key	Part Number	Description	Quantity
14	9994-032-002	Escutcheon, Upper .....	1
15	9435-025-001	Trim, Overlay-Upper (Blue) .....	1
15	9435-033-001	Trim, Overlay-Upper (Black) .....	1
16	9994-033-001	Escutcheon, Lower .....	1
17	9435-023-001	Trim, Overlay-Lower (Blue) .....	1
17	9435-031-002	Trim, Overlay-Lower (Black) .....	1
*	9545-020-009	Screw .....	10
18	9412-154-002	Nameplate Stack Dryer Express (Blue).....	.1
18	9412-167-001	Nameplate Stack Dryer Express (Black) .....	.1
21	9866-005-002	Lint Drawer Assembly (Blue).....	2
21	9866-005-005	Lint Drawer Assembly (Black) .....	2
21	9435-024-001	Overlay Trim, Lint Drwr (Blue).....	1
21	9435-032-002	Overlay Trim, Lint Drwr (Black) .....	1
*	9532-074-003	Felt Seal ( back of lint screen assembly ) .....	2
*	9805-033-002	Lint Screen Assembly ONLY (no front) .....	2
*	9555-057-008	Replaceable Lint Screen Only .....	.2
24	8650-026-002	Lock and Key, Lint Drawer Thumb Turn .....	2
*	9095-044-001	Cam, Lock.....	.2
*	9545-008-001	Lint Screen Strap Hold Down Screws 10Bx 1/4 .....	32
22	9857-187-001	Controls Assy, Electronic w/Membrane Switch (Blue) .....	1
22	9857-187-003	Controls Assy, Electronic w/Membrane Switch (Black) .....	1
22	9801-096-001	Membrane Switch Assy (Blue).....	1
22	9801-105-001	Membrane Switch Assy (Black) .....	1
*	9627-885-001	Harness, Electronic Control .....	.1
*	6292-006-007	Cam, Lock Control .....	1
*	9627-886-001	Harness, Heat Sensor .....	.1
*	9277-041-017	Insulation Cabinet Cover .....	.1
20	9501-004-004	Sensor Temp Control (10K Ohms).....	2
*	9545-045-005	Screw, Round Head (Mounts sensor; phillips head).....	2
*	9209-037-002	Gromm.et, 3/16 ID .....	2
*	8544-006-001	Leg, Leveling 1/2" .....	4
*	9074-320-001	Cover, Cabinet (Top) .....	1
*	9732-253-001	DDAD Kit for Dryers without Neutral and using 208-240 volt....	1
*	9732-102-013	LP Kit for DDAD Dryers 108K BTU .....	1
*	9732-243-001	Stack Dryer Trunion Puller .....	1
*	9555-057-010	Replaceable Lint Screen Fine Mesh Only .....	.1
*	9277-054-001	Insulation-Front Panel-Top Half .....	2
*	9277-054-002	Insulation-Front Panel-Lower Half .....	2
*	9501-008-002	Bracket for Heat Sensor Mounting (Under Basket) with Sensor ..	2
*	8640-276-002	Wire Nut Connector Grey.....	4
*	9527-007-002	Standoff Wire Saddle .....	8
*	9544-041-002	Strap - Bead Tie .....	1

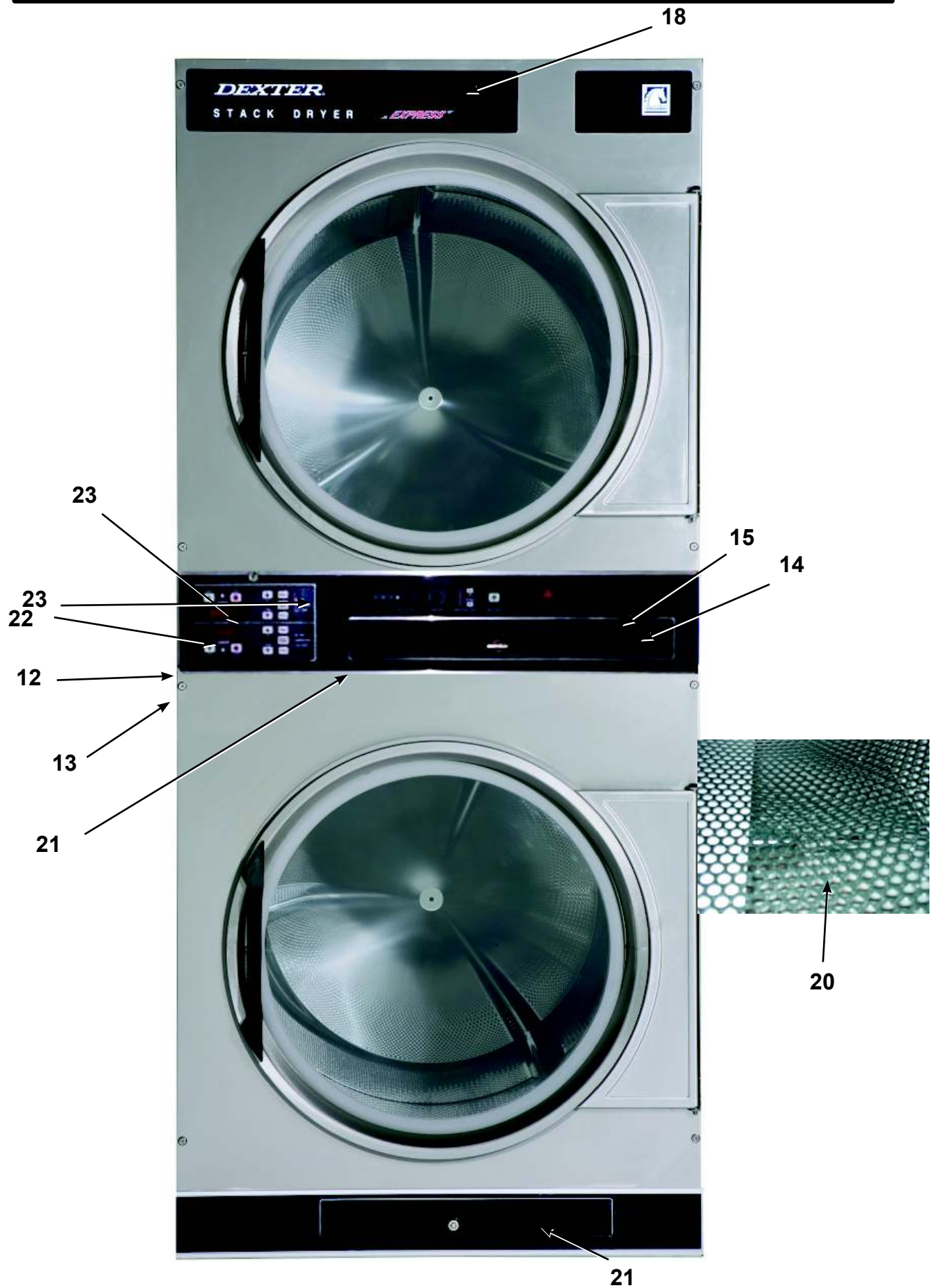

# OPL Control Board

Key	Part Number	Description	Quantity
1	9857-187-001	Control Assembly (Blue) .....	1
1	9857-187-003	Control Assembly (Black) .....	1
2	9471-017-001	PCB Control Board .....	1
3	9471-018-001	PCB Display Board .....	1
4	9500-007-001	Cable, Upper Control Long .....	1
5	9500-007-002	Cable, Lower Control Long .....	1
6	9801-096-001	Membrane Switch Assembly (Blue) .....	.1
6	9412-167-001	Membrane Switch Assembly (Black).....	.1
7	8636-024-001	Fuse, 600ma / 250v .....	2
*	9627-885-001	Harness Main Control OPL Stack Dryer .....	1

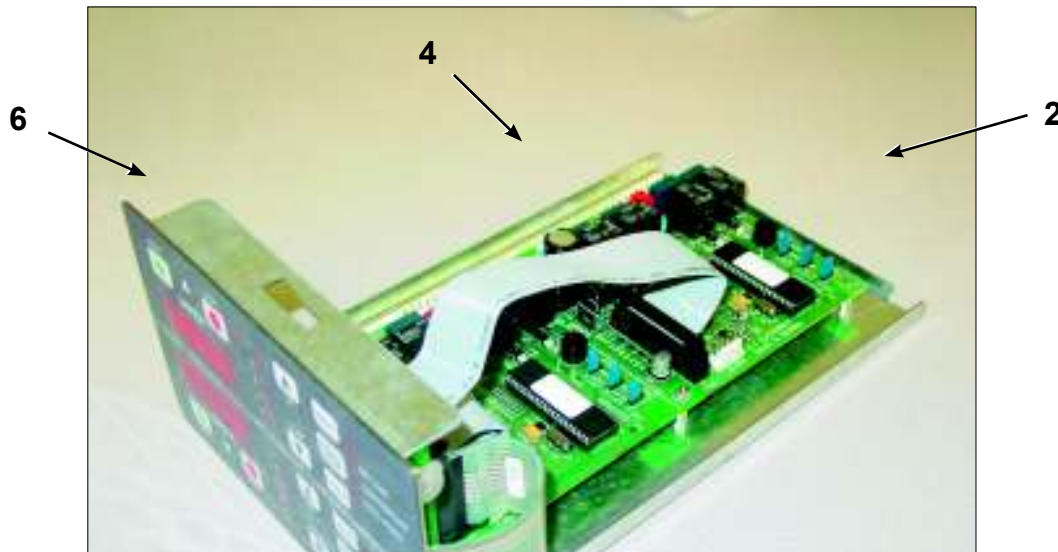
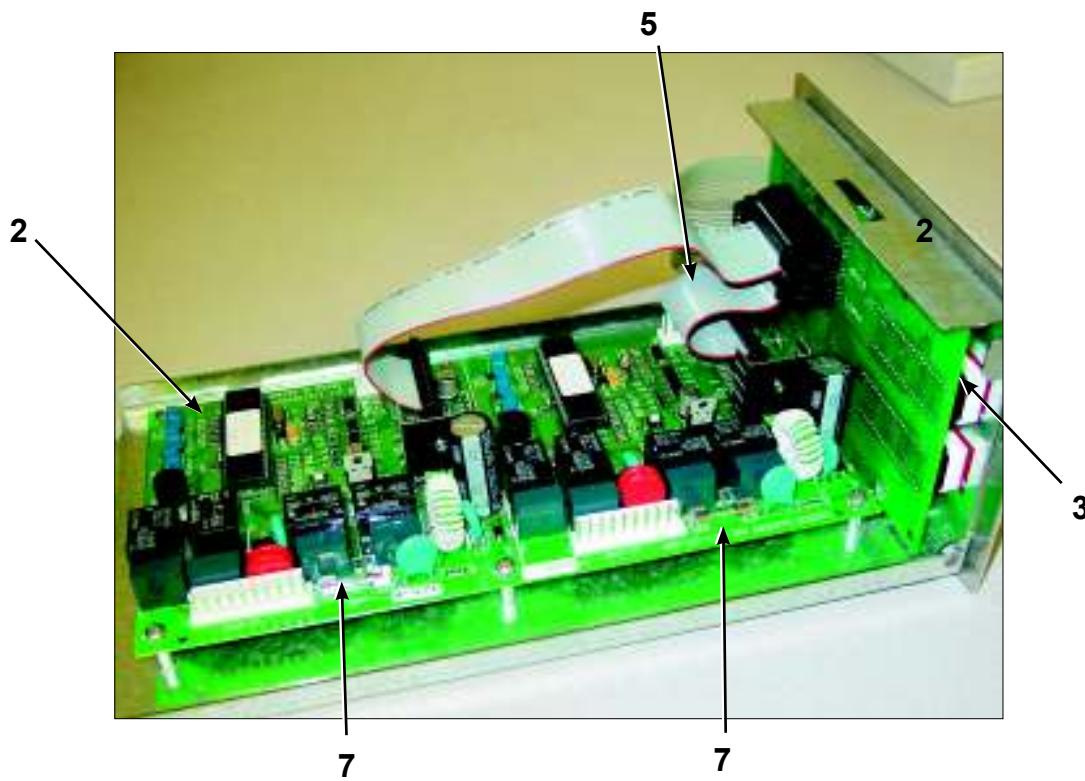



# Bearing Housing Group

Key	Part Number	Description	Quantity
1	9241-189-002	Housing, Bearing .....	2
2	9036-159-003	Bearing, Ball Rear.....	2
*	9538-183-001	Spacer, Bearing .....	2
*	9036-159-001	Bearing, Ball Front.....	2
5	9545-017-017	Bolt, 1/2 x 3/4.....	8
7	8640-417-002	Nut, 1/2 .....	8
*	9803-201-001	Bearing Housing Complete Ass'y (includes bearings,spacer) .....	2
4	9545-017-018	Screw 1/2 x 1 1/2 .....	4

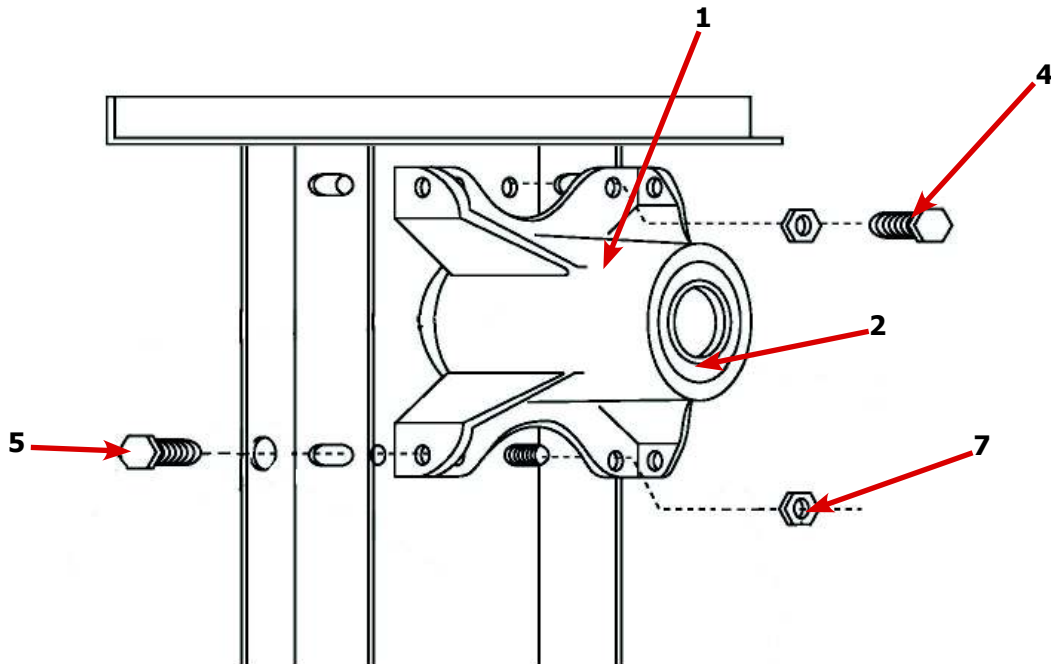
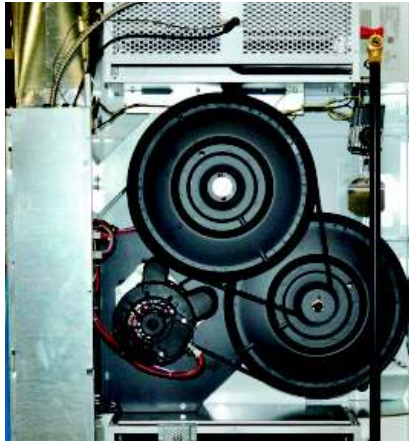

# Burner Housing Group - 50lb

Key	Part Number	Description	Quantity
*	9803-207-001	Housing Assembly, Burner .....	.2
1a	9452-730-001	Service Burner Plate Front... ..	2
1	9452-729-001	Service Plate baffle Recirculation Chamber Clean Out .....	2
*	9545-008-006	Screws .....	8
2	9545-008-001	Screw .....	16
18	9003-220-001	Angle, Burner Support .....	2
*	9545-008-006	Screw .....	.4
17	9048-020-002	Burner, Main .....	4
*	9545-008-006	Screw 10AB x 3/8" .....	4
*	9454-824-001	Panel, Back Burner Housing.....	2
4	9545-008-001	Screw 10B x1/4" .....	.8
5	9875-002-003	Electrode Assy, Ignition .....	2
19	9545-045-001	Screw, Electrode Mtg 8B x 1/4" .....	4
7	9379-186-001	Valve, Gas Shut Off .....	1
8	9857-134-001	Control Assy, Gas .....	2
9	9381-012-001	Manifold, Assembly 2 Part 1 Piece .....	2
*	9425-069-021	Orifice, Burner-Natural #29.....	4
*	9425-069-022	Orifice, Burner-LP #46.....	4
10, 14	9029-175-001	Bracket, Manifold .....	.4
22	8615-104-038	Pipe Plug in end of Burner Manifold .....	2
*	9545-008-006	Screw .....	.4
12	9576-203-002	Thermostat, Hi-Limit .....	2
*	9538-142-001	Spacer, Hi-Limit .....	4
*	9545-045-007	Screw 8B x 3/4" .....	4
13	9074-329-001	Cover, Hi-Limit Stat Ignitor .....	2
*	9545-008-006	Screw .....	6
*	9576-207-008	Thermostat, Safety Shutoff .....	2
*	9545-008-006	Screw .....	4
15	9825-062-001	Cover, Safety Stat .....	2
*	9545-008-006	Screw .....	4
16	9857-116-003	Control, Ignition Fenwall (3 trybox) .....	2
*	9732-102-013	Kit, LP Conversion DDAD Kit .....	.2
*	9838-018-003	Welded One Piece Gas Pipe Assembly .....	1

# Burner Housing Group Photos - 50lb

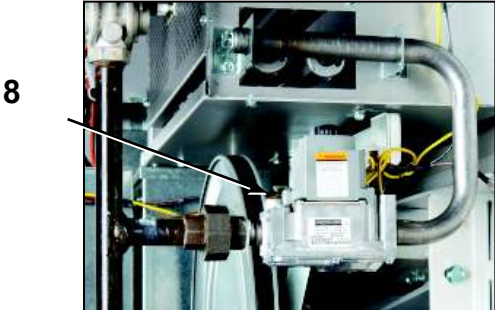
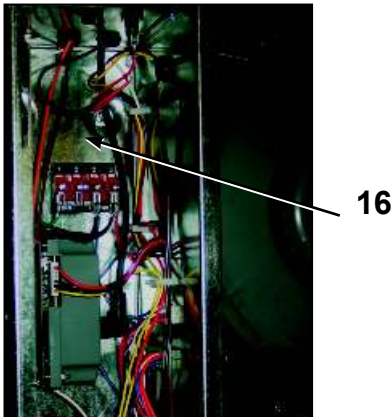
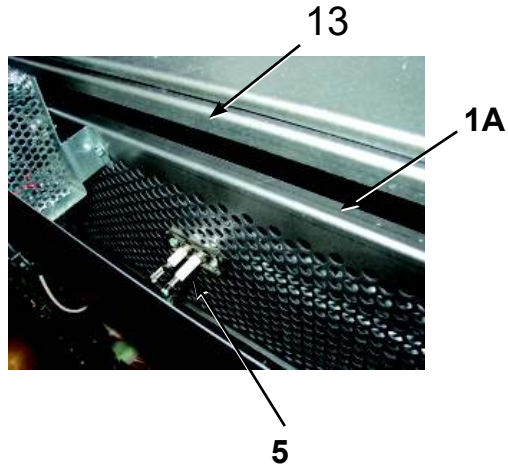
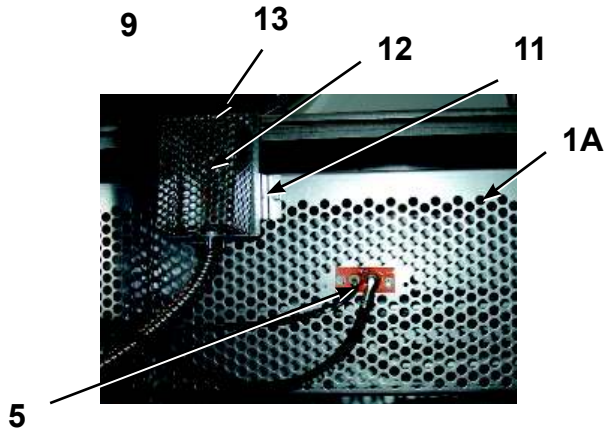
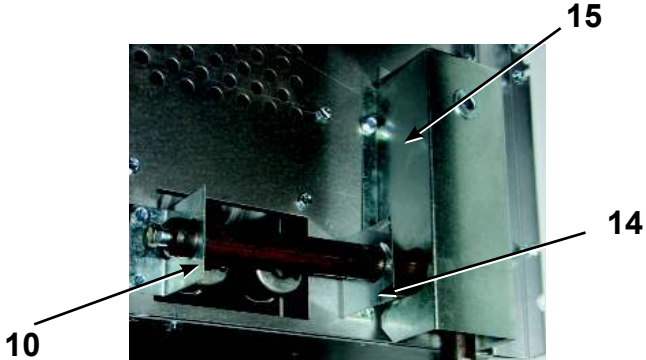
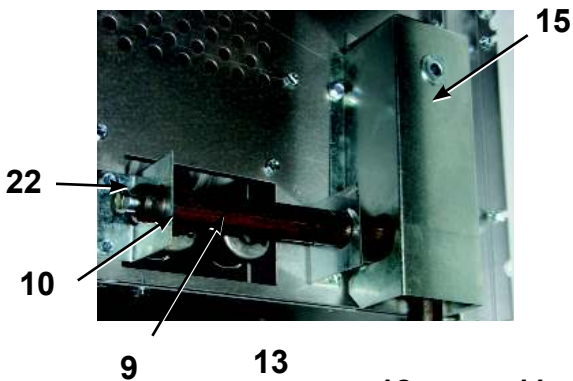
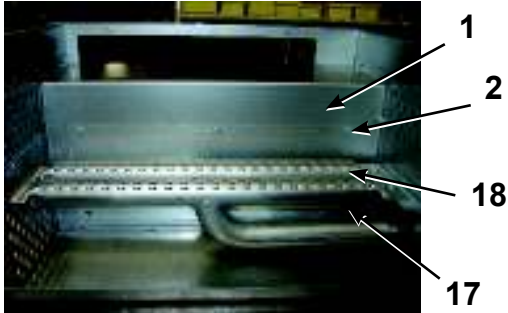
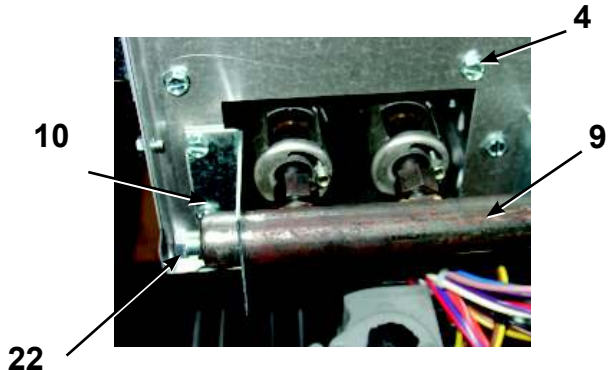

# Rear View

Key	Part Number	Description	Quantity
*	9627-861-001	Wire Harness, Overtemperature Switch Upper .....	1
*	9801-098-001	Switch Assy, Air Flow .....	2
1	9539-461-009	Switch, Air Flow .....	2
2	9029-200-001	Bracket, Switch-Air Flow .....	2
*	8640-401-001	Nut, Special Twin .#4-40 .....	2
*	9550-169-003	Shield, Switch .....	2
3	9008-007-001	Actuator, Switch.....	2
4	9451-169-002	Pin, Cotter.....	2
5	9545-020-001	Screw, 4-40x 5/8 .....	4
7	9376-322-001	Motor, Drive .....	2
27	9453-169-013	Motor-Pulley, Driver.....	2
*	9452-770-001	Plate, Motor Mounting .....	2
9	9962-018-002	Plate, Impeller Mounting.....	2
*	9538-163-006	Spacer, Motor Mounting .....	8
*	9545-029-008	Screws, Hex Cap.....	8
*	8641-582-003	Lock Washers .....	8
*	9545-018-019	Screw HXHD 1/4-20 x 2 1/2 .....	8
*	8641-581-017	Washer-Flat, 1/4 x 7/8 .....	32
*	9538-166-006	Spacer, Metal.....	8
12	9991-053-001	Support Assy, Intermediate pulley .....	2
12	9545-029-010	Bolt, Rd Hd 3/8-16 x 1 1/4 .....	6
12	8640-415-004	Nut Flange Wizlock 3/8 - 16 .....	6
12	8641-581-035	Washer, Flat .....	6
13	9545-029-003	Bolt, 3/8 - 16 x 1 1/2.....	2
14	9861-022-001	Arm Assy-Tension, Complete.....	2
*	9487-200-003	Ring-Retaining .....	6
16	9908-048-003	Pulley Assy, Intermediate w/Bronze Flange Bearing .....	2
*	9036-145-002	Bearing - Bronze Flange .....	4
17	9908-047-002	Pulley Driven, Tumbler.....	2
*	9487-234-005	Tolerance Ring.....	2
34	8641-581-026	Washer, Flat 1/2" for Tumbler Pulley .....	2
35	9545-017-009	Bolt, 1/2" - 13 x 1 1/4 .....	2
36	8641-582-016	Washer, Star 1/2" for Tumbler Pulley .....	2
*	9538-184-001	Spacer, Shaft.....	2
19	9040-076-009	Belt, Drive Motor and intermediate.....	2
20	9040-073-011	Belt, Driven-intermediate to.....	2
21	9534-151-000	Spring, Tension.....	2
22	9099-012-005	Chain Tension .....	2
23	9248-022-002	Hook, Tension .....	2
*	9451-146-001	Pin, Damper Hinge.....	2
*	8520-141-000	Nut, Spring.....	4
*	9825-334-001	Cover, Duct-Upper .....	1
25	9973-032-001	Heat Recirculation Assembly Duct .....	2
*	9545-028-013	Set Screw.....	2
30	9278-043-001	Impeller .....	2
*	9125-007-001	Damper, Exhaust Duct - Upper .....	1
*	9125-007-002	Damper, Exhaust Duct - Lower .....	1
*	8520-141-000	Nut, Spring.....	4
*	9545-008-026	Screw #10B x 1/2 .....	14
*	9074-335-001	Cover, Duct - Lower .....	1
*	9545-008-024	Screw #10AB x 3/8 .....	58
*	9029-173-001	Bracket for Wire Harness Under Burner Housing .....	2

# Rear View Photos - 50lb

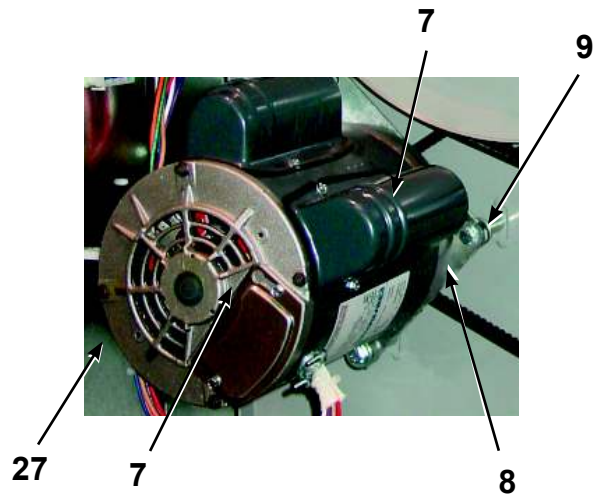
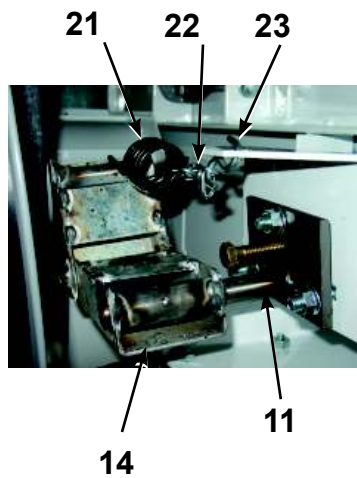
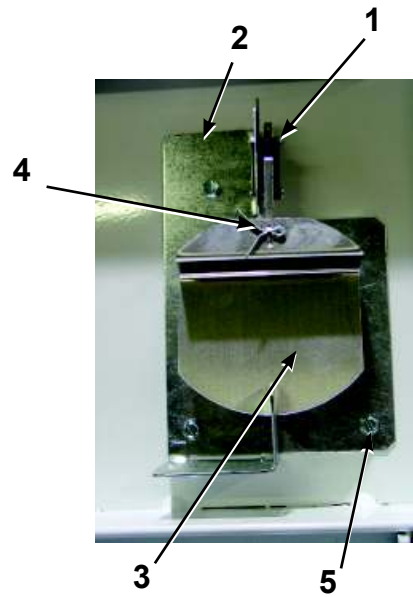
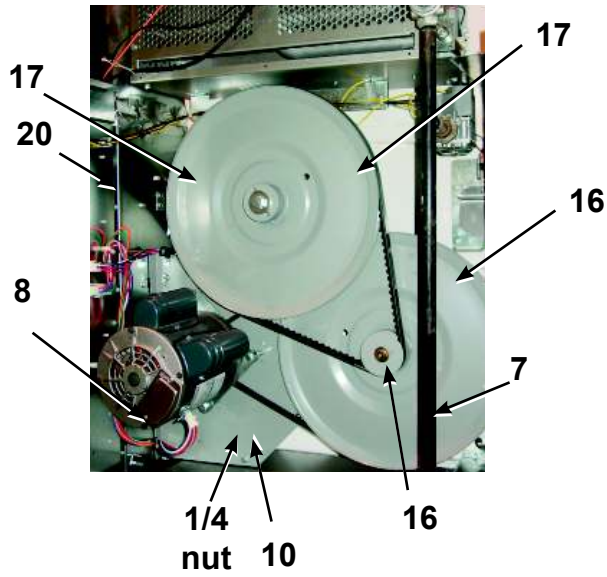
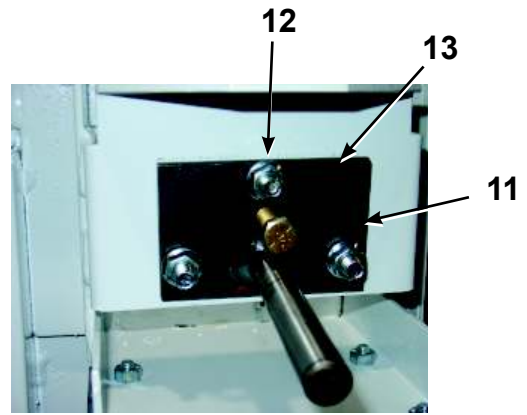
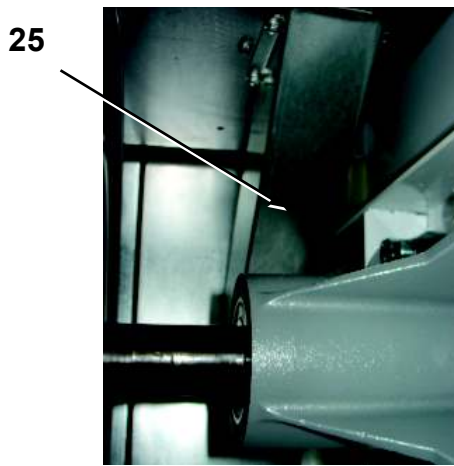

# Rear Panel & Cover Group - 50lb

Key	Part Number	Description	Quantity
1	9208-090-001	Rear Guard Side Panel 1.....	2
4	9545-008-024	Screws 10 AB x 3/8.....	30
*	9208-089-001	Rear Guard Top, Lower.....	1
7	9545-082-024	Screws 10 AB x 3/8.....	6
8	9208-089-001	Rear Guard Back Panel.....	2
10	8502-600-001	Label Warning & Notice.....	1
11	8502-645-001	Label - Instructions.....	1
12	9109-113-001	Transition Assembly Outlet.....	1
13	9074-320-001	Top Cover Dryer Panel.....	1
14	9550-188-001	Top Burner Housing Heat Shield.....	1

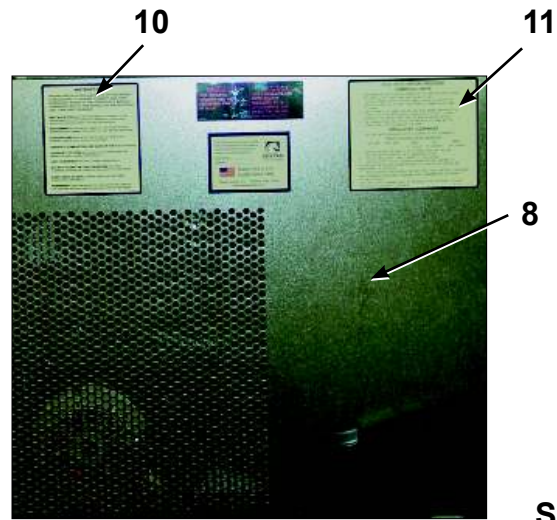
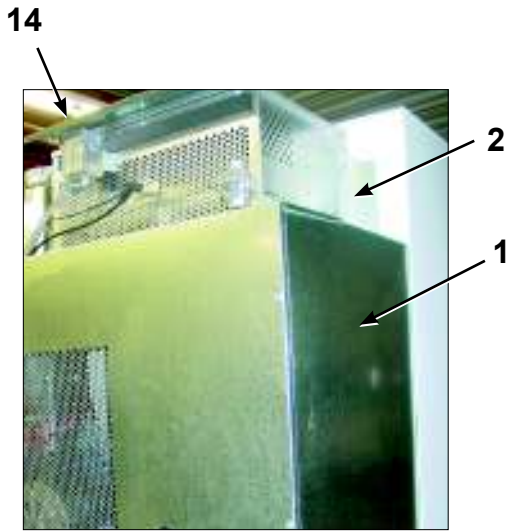

Screws

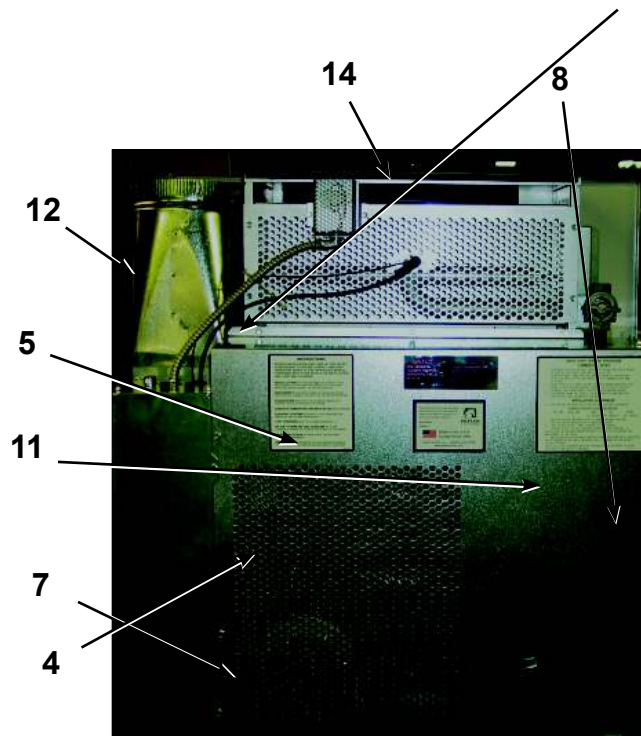
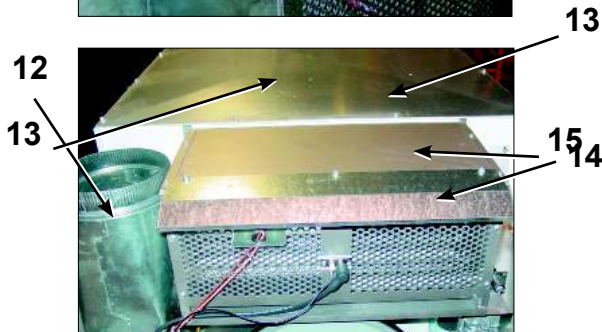
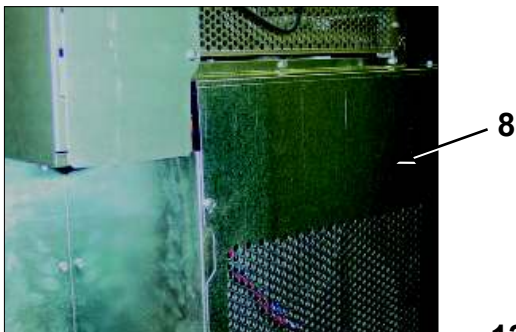

# Tumbler Group

Key	Part Number	Description	Quantity
1	9848-148-001	Tumber Assembly Galvanized.....	2
*	9848-148-002	Tumbler Assembly Stainless Steel.....	2
*	9848-149-001	Tumbler Assembly Galvanized w/spider.....	2
*	9848-149-002	Tumbler Assembly Stainless w/spider.....	2
2	9568-013-001	Spider Assembly .....	2
3	9497-226-002	Rod, Tumbler .....	6
5	8640-417-005	Nut, 1/2 - 13 .....	.6
4	8641-590-002	Washer, Special .....	6
6	9552-013-000	Shim .....	.AR

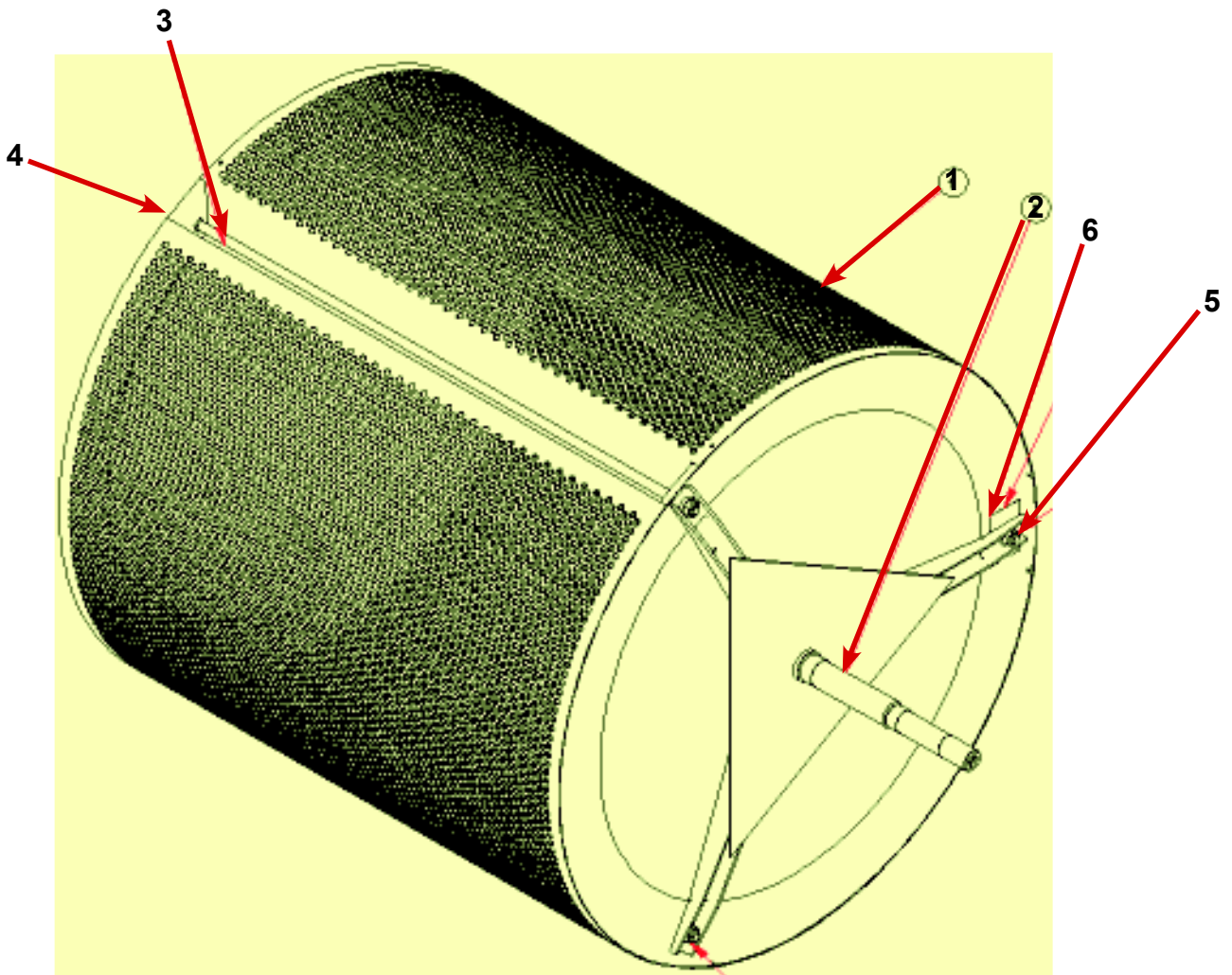

# Control Assembly Group

Key	Part Number	Description	Quantity
*	9857-187-003	Control Assmby Complete (all below included) .....	1
*	9074-317-001	Control Box Cover .....	1
1	8653-068-003	Connector Conduit 3/8" STR.....	1
2	9558-029-003	Strip Terminal Marker (Behind Input Power) to above #3 .....	1
3	9897-035-001	Terminal Block Assembly Main Power Inlet .....	1
*	9545-008-024	Screws 10AB x 3/8" .....	4
*	9627-859-003	Wire Harness - Power Main .....	1
4	8220-001-478	Wire Assembly Green 7" .....	1
5	9545-008-027	Screw # 10-32 x 12 Green .....	1
*	8641-582-006	Lockwasher Ext Tooth #10.....	1
6	9897-026-002	Terminal Block Main Power Middle .....	1
7	9897-026-001	Terminal Block.....	2
*	9545-045-012	Screw #8 ABx1 2 for terminal block.....	6
8	8711-013-001	Transformer Control.....	1
*	9545-008-024	Screws 10AB x 3/8" .....	4
9	9857-182-001	Ignition Control .....	2
*	9545-008-018	Screws 10AB x 3/4" .....	4
10	9631-403-009	Wire Assembly High Voltage Upper .....	1
11	9627-867-005	Wire Harness Ignition Control Upper .....	1
12	9631-403-008	Wire Assembly High Voltage Lower .....	1
13	9627-867-006	Wire Harness Ignition Control Lower .....	1
*	9053-067-002	Bushing Wire 7/8".....	4
14	9200-001-002	Fuseholder Assembly .....	3
*	8636-018-001	Fuse 1.5 Amp.....	2
*	8636-018-004	Fuee 2.5 Amp.....	1
15	5192-299-001	Relay Power .....	2
*	9545-045-012	Screws Power #8 AB x 1/2".....	4
*	8220-062-036	Wire Assembly Red/Black 14" .....	1
*	8220-062-037	Wire Assembly Red/White 14" .....	1
16	9627-864-006	Wire Harness Motor Extension.....	2
17	9527-007-001	Stand Off - Wire Saddle / Arrowhead .....	5
18	9627-863-001	Wire Harness Main Extension Access Under Burner Housing .....	4

Control Protection Fuse 2.5 Amp **14**      **1**      **14** Ignition Upper Pocket Protection Fuse 1.5 Amp

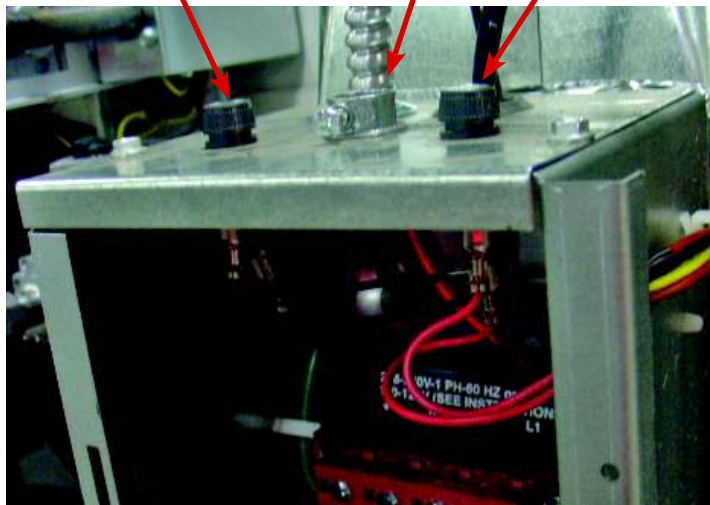

Not Shown:  
24VAC Ignition Lower  
Pocket Protection  
Fuse



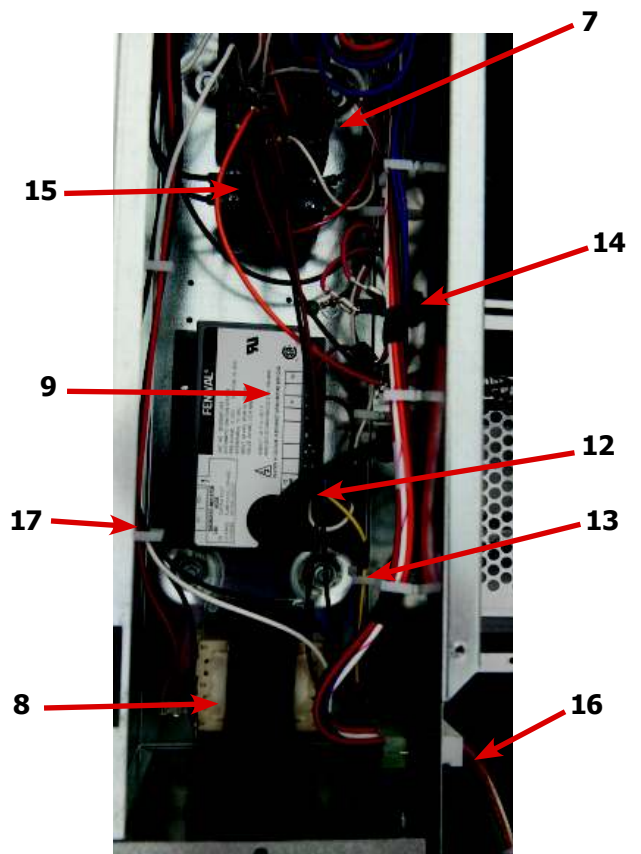
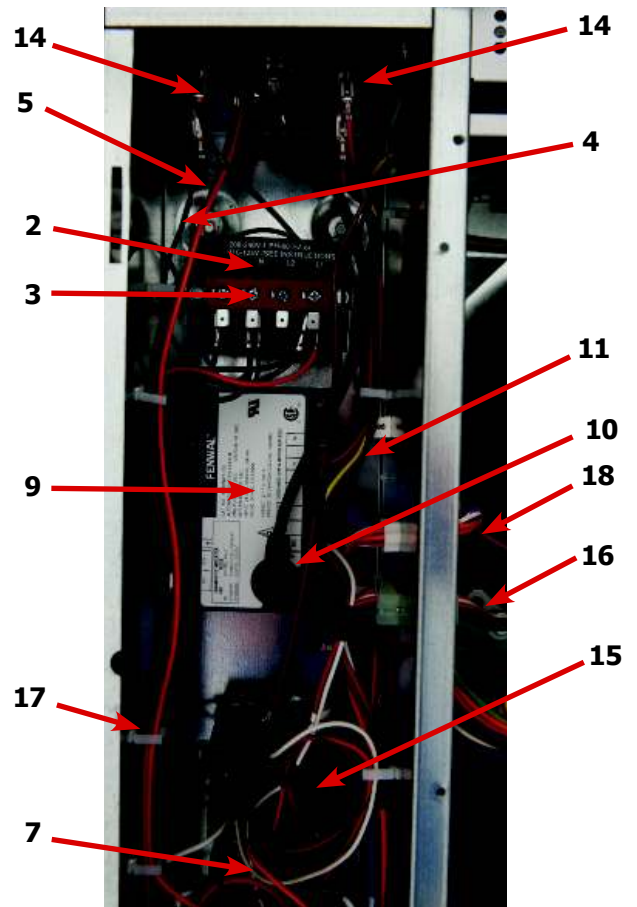
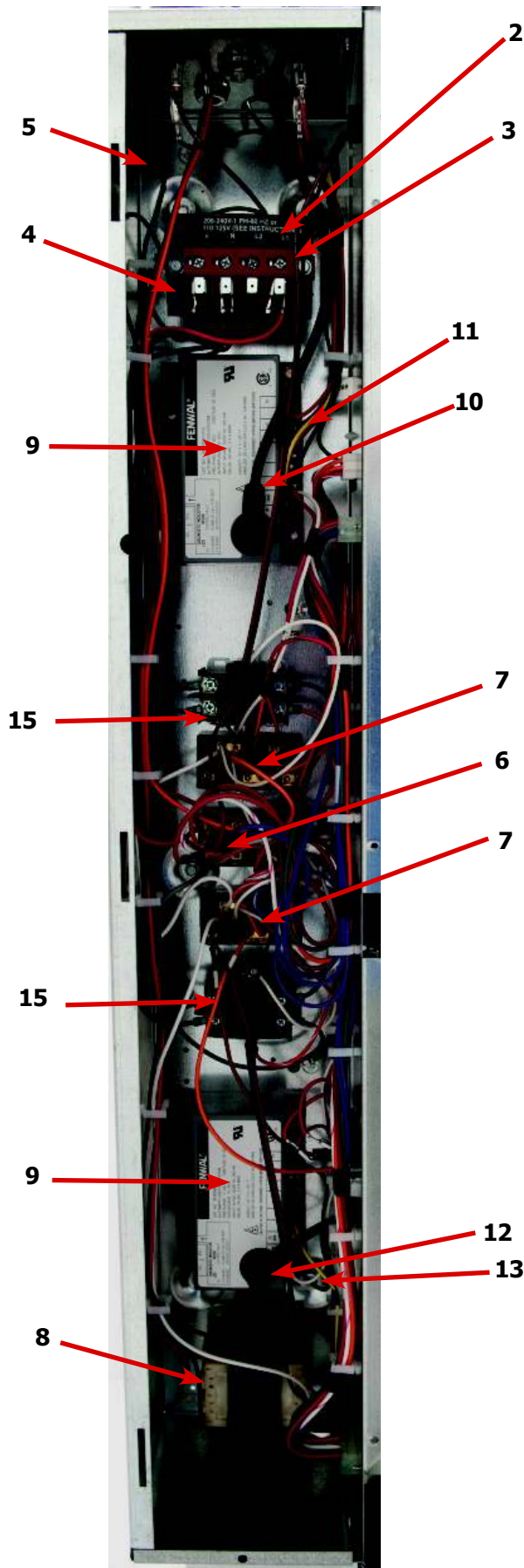

---

# Door Switch Group

**Part Number**  
9539-487-001

**Description**  
Door Switches ..... 2

**Quantity**

