



Section 6:

Parts Data

DC50X2

24V Control

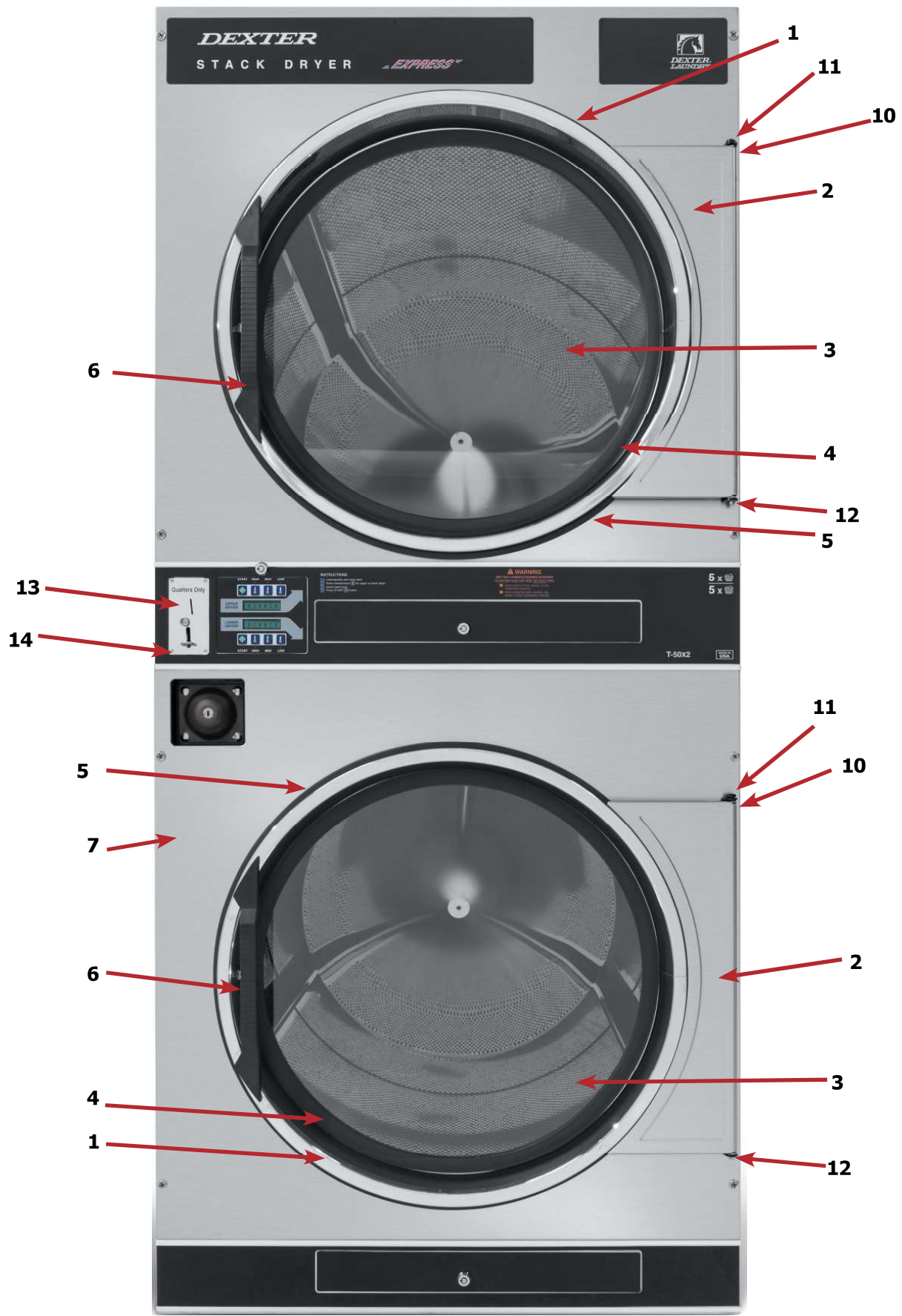

Cabinet Group

Key	Part Number	Description	Quantity
*	9960-285-008	Door Assy., Loading Complete-Wht	2
*	9960-285-011	Door Assy., Loading Complete-SS	2
*	9960-285-007	Door Assy., Loading Complete-Chrome/BLK/SS	2
1	9960-284-002	Door Assy., Loading-SS(ring only)	2
1	9960-284-004	Door Assy., Loading-Chrome(ring only)	2
2	9982-353-002	Plate Assy., Hinge (Wht) No Pin	2
2	9982-353-001	Plate Assy., Hinge (SS) No Pin.....	2
*	9545-012-015	Screw, Hinge to Door	8
*	8640-413-002	Nut, Hinge to Door	8
3	9212-002-004	Glass, Door	2
4	9206-413-002	Gasket, Glass Black.....	2
*	9548-117-000	Support, Door Glass	2
*	8545-064-001	Tool Install Dryer Door Gasket.....	1
5	9206-420-005	Gasket, Outer Rim Black.....	2
6	9244-082-001	Handle, Loading Door	2
*	9545-018-017	Screw, Handle 1/4-20 x 3/8	4
*	9531-033-003	Stud, Door Catch	2
*	8640-413-001	Nut, Hex	2
*	8640-413-003	Nut, Acorn	2
*	9086-015-002	Catch, Loading Door	2
*	8638-190-009	Pop Rivet for mtg. catch	4
*	8641-582-006	Lockwasher	4
*	8640-399-001	Spring Nut	6
7	9989-521-003	Panel Assy., Front- Lower (Wht)	1
7	9989-521-001	Panel Assy., Front- Lower (SS)	1
8	9989-517-003	Panel Assy., Front- Upper (Wht)	1
8	9989-517-001	Panel Assy., Front- Upper (SS)	1
*	9277-054-001	Insulation Front Panel, half moon (top).....	2
*	9277-054-002	Insulation Front Panel, half moon (bottom).....	2
9	9545-008-014	Screw, FLHDCR, 10B x 1.....	14
*	8641-585-001	Lockwasher	6
*	8640-399-001	Nut, Spring	12
10	9544-069-002	Strap, Hinge (Wht)	2
10	9544-069-005	Strap, Hinge (SS/Black)	2
*	9545-012-028	Screw, Hinge to Panel	8
11	9545-052-001	Screw, Door to Hinge Strap (Special Black Type)	2
12	8641-436-003	Washer, Fiber	2
13	9021-041-001	Acceptor, Coin	1
*	9486-149-001	Retainer, Coin Acceptor	2
14	9545-053-002	Screw	4
*	9801-099-001	Switch, Optical.....	1

Cabinet Group Continued

Key	Part Number	Description	Quantity
15	9994-032-001	Escutcheon, Upper	1
16	9435-039-002	Trim, Overlay-Upper Blue.....	1
16	9435-039-001	Trim, Overlay-Upper Black	1
17	9994-033-001	Escutcheon, Lower	1
18	9435-023-001	Trim, Overlay-Lower Blue.....	1
18	9435-031-001	Trim, Overlay-Lower Black	1
*	9545-020-009	Screw	20
19	9412-167-002	Nameplate Stack Dryer Express Blue.....	.1
19	9412-167-001	Nameplate Stack Dryer Express Black1
20	9866-005-001	Lint Drawer Assembly Blue	2
20	9866-005-004	Lint Drawer Assembly Black.....	2
21	9435-024-001	Overlay Trim, Lint Drwr-Blue	1
21	9435-032-001	Overlay Trim, Lint Drwr-Black.....	1
*	9532-074-003	Felt Seal (back of lint screen assembly)	2
*	9805-033-002	Lint Screen Assembly ONLY (no front)	2
*	9555-057-008	Replaceable Lint Screen Only.....	.2
22	8650-012-004	Lock and Key, Lint Drawer	2
*	6292-006-010	Key 6101 only	2
*	9095-043-001	Cam, Lock.....	.2
*	9545-008-001	Lint Screen Strap Hold Down Screws 10Bx 1/4	32
23	9857-198-002	Controls Assy, Blue	1
23	9857-198-004	Controls Assy, Black.....	1
*	9627-859-003	Harness, Electronic Control1
24	8650-012-003	Lock and Key, Control	1
*	9095-041-001	Cam, Lock	1
*	6292-006-007	Key only 6324.....	1
*	9627-855-003	Harness, Heat Sensor1
*	8640-276-002	Wire Nut Connector Grey.....	4
25	9501-004-003	Sensor Temp Control	2
26	9501-008-001	Bracket for Heat Sensor Mounting (Under Basket) w/ sensor..	2
*	9545-045-005	Screw, Round Head (Mounts sensor; phillips head).....	2
*	9209-037-002	Gromm.et, 3/16 ID	2
*	8544-006-001	Leg, Leveling 1/2"	4
*	9074-320-001	Cover, Cabinet (Top)	1
*	9277-041-017	Insulation Cabinet Cover1
*	9732-276-001	Kit for Dryers without Neutral and using 208-240 volt	1
*	9732-102-013	LP Kit for 50Lb Stk Dryers.....	1
*	9732-243-001	Stack Dryer Trunion Puller.....	1
*	9544-041-002	Strap - Bead Tie	1
27	9942-038-005	Vault, Coin Box	1
*	9545-008-024	Screws, Mounting-Coin Vault	2
28	9897-099-002	Coin Box Assy, Large Blue	1
28	9807-099-004	Coin Box Assy, Large Black	1

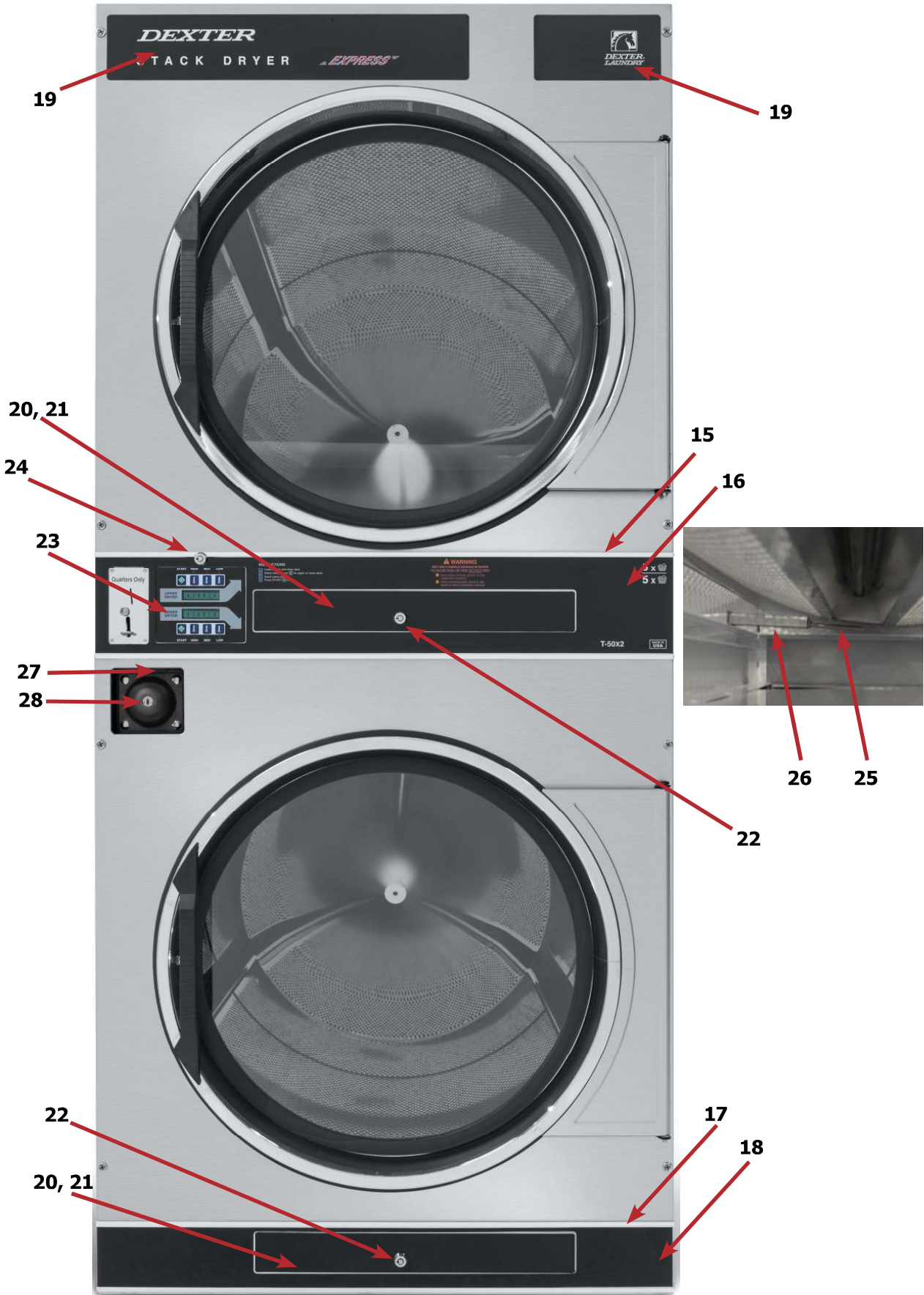

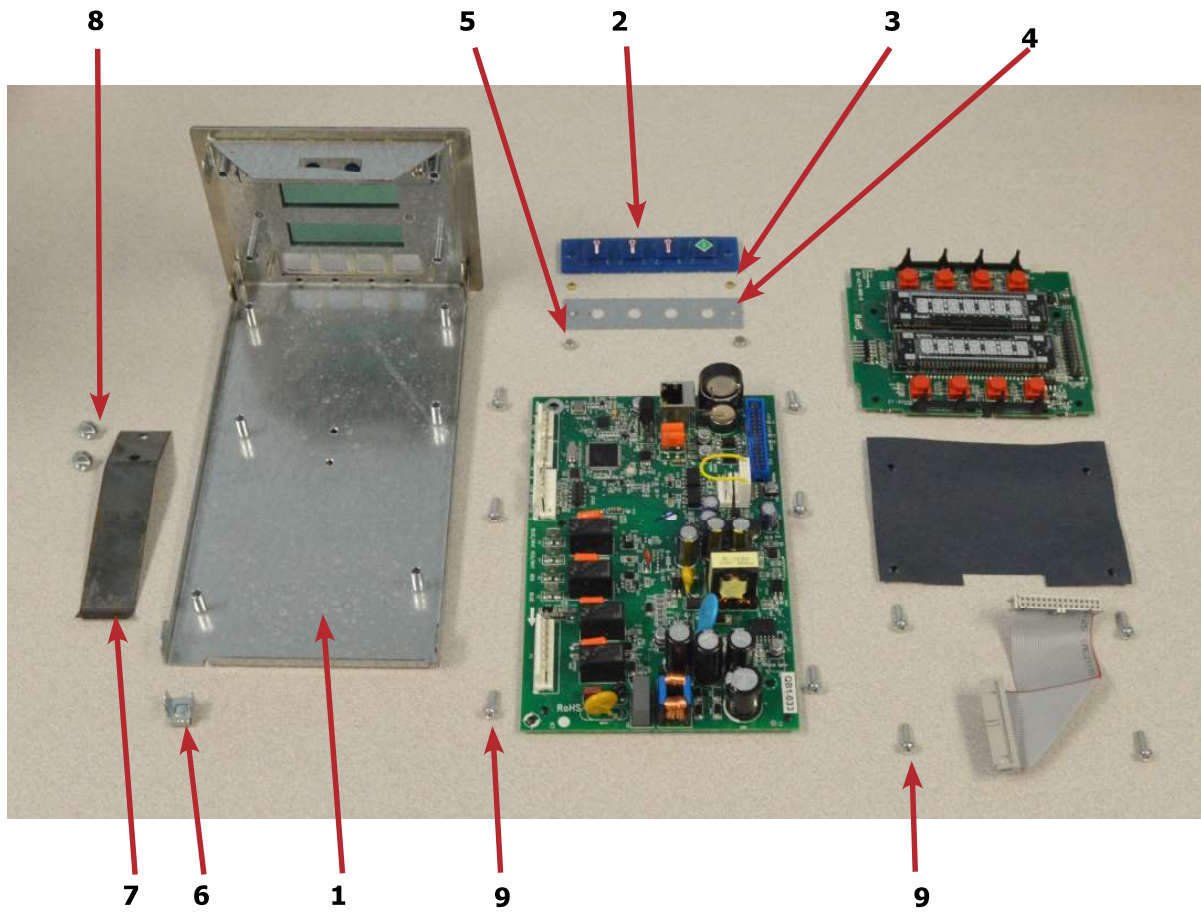

Control Parts Group

Key	Part Number	Description	Quantity
*	9857-198-002	Controls Assy, Electronic Mounted With Membrane Switch, BLU...	1
*	9857-198-004	Controls Assy, Electronic Mounted With Membrane Switch, BLK...	1
1	9826-008-001	Trough Assembly	1
2	9035-062-002	Button-Push, Control, Black	2
2	9035-062-001	Button-Push, Control, Blue	2
3	9538-166-011	Spacer-Metal, 4mm	4
4	9486-158-001	Retainer-Push Button	2
5	8640-424-002	Nut-Hex, Elastic stop, #4-40	4
6	8652-130-038	Terminal-Grounding clip	1
7	9534-365-001	Spring-Flat, Control	1
8	9545-008-001	Screw-Hex, #10B x 1/4	2
9	9545-044-010	Screw-Hex, #10B x 1/4	10
9	8641-582-005	Washer-External tooth, #6	10
10	9435-038-001	Overlay-Control, Coin, Black	1
10	9435-038-002	Overlay-Control, Coin, Blue	1
11	9021-041-001	Acceptor-Coin, Optical	1
*	9486-149-001	Retainer, Coin Acceptor	1
12	9545-053-002	Screw	4
*	9801-099-001	Optical Sensor, Replacement.....	1

Note: Jumpers required if using 1.5 Control on Older Machines (P9 Connection)

*	8220-155-001	Wire Assy, Jumper, 30Lb Stack Coin	1
*	8220-155-002	Wire Assy, Jumper, 50Lb Stack Coin	1

Door Switch Group

Part Number	Description	Quantity
9539-487-001	Door Switches	2



Hinge Plate Cover

1	9074-340-002	Cover-Hinge, Black	2
2	8636-008-010	Screw-TRHDCR, 10B x 3/8, Black.....	4

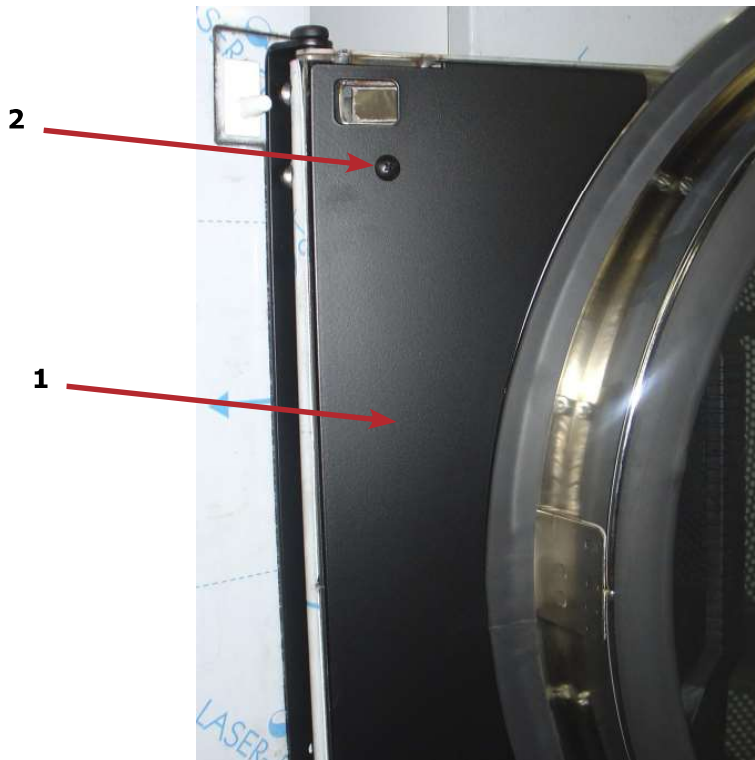

Bearing Housing Group

Key	Part Number	Description	Quantity
1	9241-189-002	Housing, Bearing	2
2	9036-159-003	Bearing, Ball Rear.....	2
*	9538-183-001	Spacer, Bearing	2
*	9036-159-001	Bearing, Ball Front.....	2
5	9545-017-017	Bolt, 1/2 x 3/4.....	8
7	8640-417-002	Nut, 1/2	8
*	9803-201-001	Bearing Housing Complete Ass'y (includes bearings,spacer)	2
4	9545-017-018	Screw 1/2 x 1 1/2	4

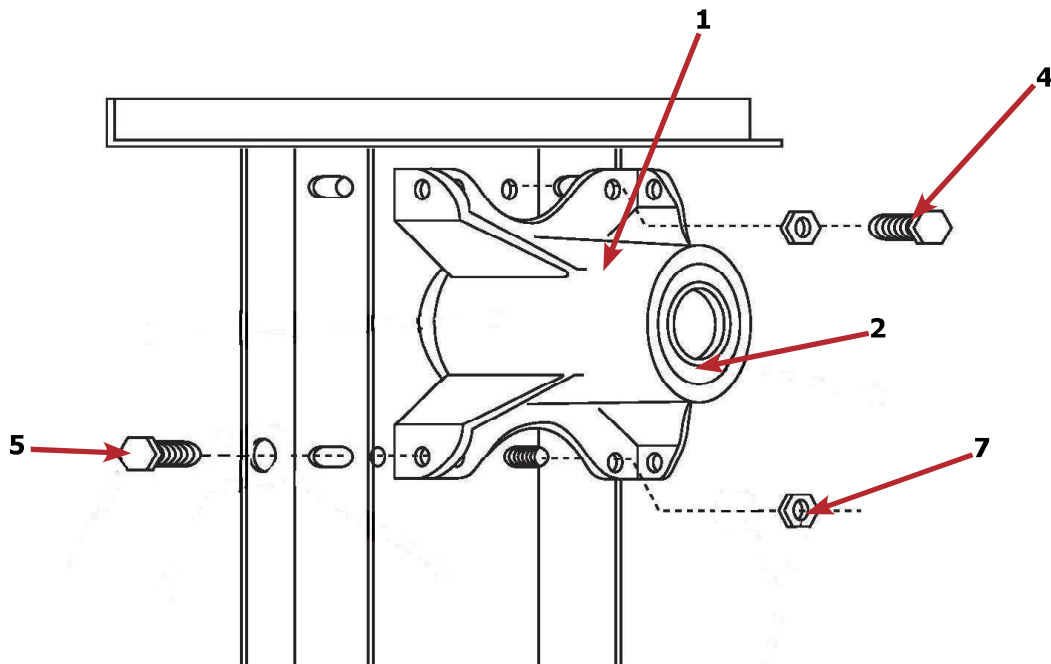

Burner Housing Group

Key	Part Number	Description	Quantity
*	9803-207-001	Housing Assembly, Burner2
1a	9452-730-001	Service Burner Plate Front... ..	2
1	9452-729-001	Service Plate baffle Recirculation Chamber Clean Out	2
*	9545-008-006	Screws	8
2	9545-008-001	Screw	16
18	9003-220-001	Angle, Burner Support	2
*	9545-008-006	Screw4
17	9048-020-002	Burner, Main	4
*	9545-008-006	Screw 10AB x 3/8"	4
*	9454-824-001	Panel, Back Burner Housing.....	2
4	9545-008-001	Screw 10B x1/4"8
5	9875-002-003	Electrode Assy, Ignition	2
19	9545-045-001	Screw, Electrode Mtg 8B x 1/4"	4
7	9379-186-001	Valve, Gas Shut Off	1
8	9857-134-001	Control Assy, Gas	2
9	9381-012-001	Manifold, Assy	2
*	9425-069-021	Orifice, Burner-Natural #27	4
*	9425-069-022	Orifice, Burner-LP #44.....	4
10	9029-175-001	Bracket, Manifold2
22	8615-104-038	Pipe Plug in end of Burner Manifold	2
*	9545-008-006	Screw4
12	9576-203-002	Thermostat, Hi-Limit	2
*	9538-142-001	Spacer, Hi-Limit	4
*	9545-045-007	Screw 8B x 3/4"	4
13	9074-329-001	Cover, Hi-Limit Stat Ignitor	2
*	9545-008-006	Screw	6
*	9576-207-008	Thermostat, Safety Shutoff	2
*	9545-008-006	Screw	4
15	9825-062-001	Cover, Safety Stat	2
*	9545-008-024	Screw	6
16	9857-116-003	Control, Ignition Fenwall (3 trybox)	2
*	9732-102-013	Kit, LP Conversion 50Lb Stack Kit2
*	9838-018-003	Welded One Piece Gas Pipe Assembly.....	1

Burner Housing Group Photos

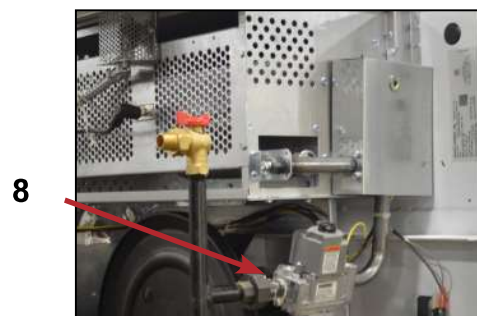
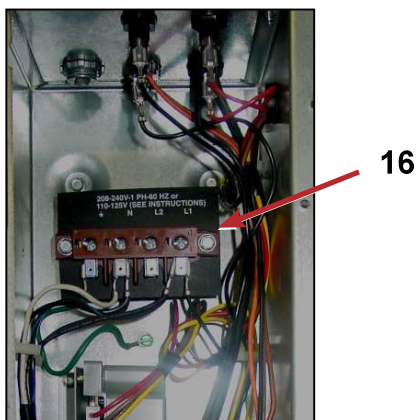
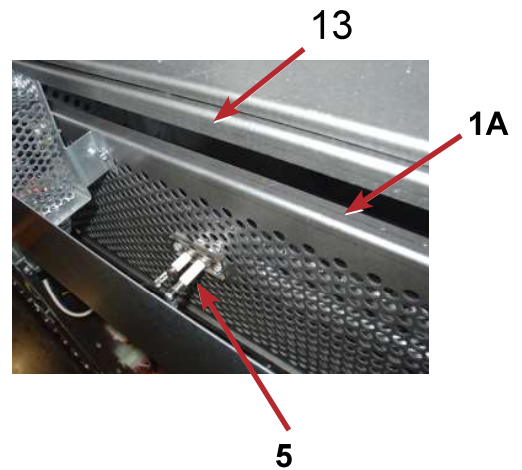
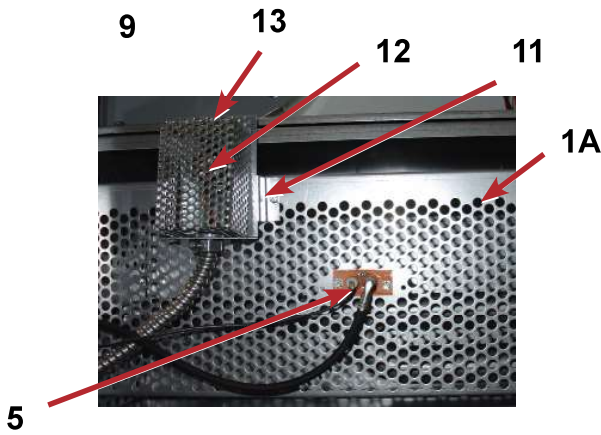
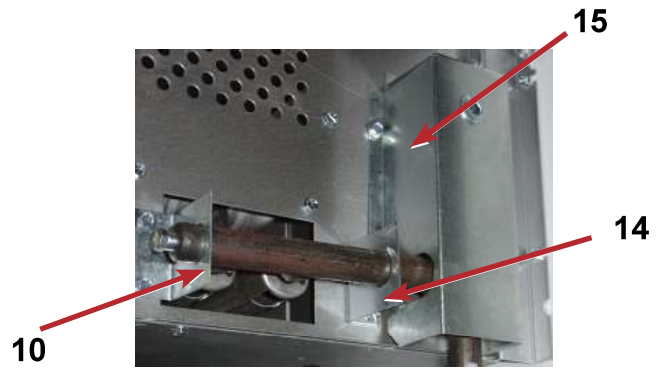
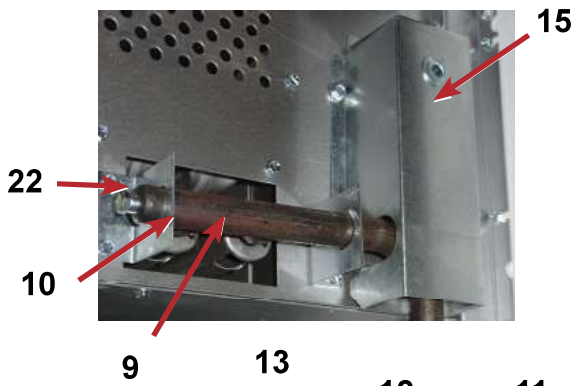
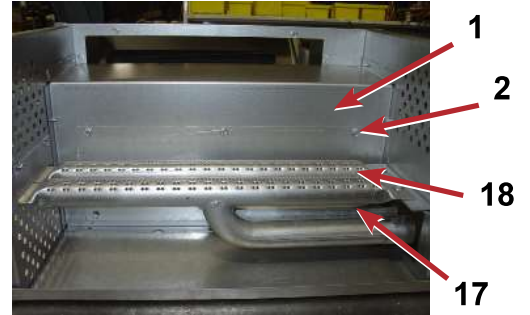
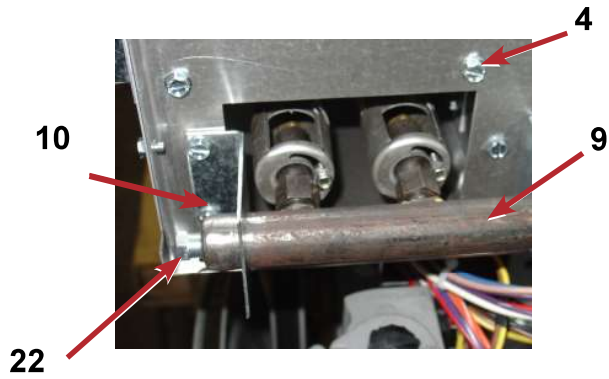

Rear View

Key	Part Number	Description	Quantity
*	9627-861-001	Wire Harness Overtemperature Switch/Air Switch.....	2
*	9801-098-001	Switch Assy, Air Flow	2
1	9539-461-009	Switch, Air Flow	2
2	9029-200-001	Bracket, Switch- Air Flow	2
3	9008-007-001	Actuator, Switch.....	2
4	9451-169-002	Pin, Cotter	2
5	9545-020-001	Screw 4-40 x 5/8"	4
*	8640-401-001	Nut, Special Twin .#4-40	2
*	9550-169-003	Shield, Switch	2
6	9376-322-001	Motor, Drive	2
7	9452-770-001	Plate, Motor Mounting	1
*	9545-029-008	Bolt 3/8" - 16 x 3/4".....	8
*	8641-582-003	Lockwash Spring 3/8	8
8	9545-018-019	Screw, Motor Plate to Back Assy. 1/4-20x 2 1/2.....	8
*	8641-582-007	Lockwasher 1/4.....	8
9	9538-163-006	Spacr.....	8
*	8641-581-017	Flat Washer 1/4 x 7/8.....	24
*	9209-086-002	Rubber Grommet.....	8
*	9538-166-006	Grommet Spacers.....	8
*	9545-028-013	Screw, Set.....	4
10	9962-018-002	Back Assy, Blower Hsg.....	2
11	9991-053-001	Support Assy, Intermed. Pulley	2
12	9545-029-010	Bolt, Rd Hd 3/8-16 x 1 1/4	6
12	8640-415-004	Nut Flange Wizlock 3/8" - 16.....	6
12	8641-581-035	Washer, Flat	6
13	9545-029-003	Bolt, 3/8-16 x 1 1/2	2
14	9861-022-001	Arm Assy-Tension, Complete	2
*	9487-200-003	Ring-Retaining	6
15	9908-048-003	Pulley Assy, Intermediate with bronze flange bearing	2
*	9036-145-002	Bronze Flange Bearing	4
16	9908-047-002	Pulley Driven Tumbler	2
17	9040-076-009	Belt, Drive Motor.....	2
18	9040-073-011	Belt, Driven Intermediate to Tumbler	2
19	9534-151-000	Spring, Tension	2
20	9099-012-005	Chain, Tension	2
21	9248-022-002	Hook, Tension	2
*	9451-146-001	Pin, Damper Hinge	2
*	9074-334-001	Cover Duct Upper	1
22	9973-032-001	Heat Recirculation Assembly Duct	2
*	9453-169-013	Motor Pulley - Driver	1
*	9545-028-013	Set Screws	2
*	9278-043-001	Impeller	2
23	8641-581-026	Washer, Flat 1/2" for Tumbler Pulley.....	2
24	9545-017-009	Bolt, 1/2"-13 x 1 1/4.....	2
25	8641-582-016	Washer, Star 1/2" for Tumbler Pulley	2
*	9545-008-001	Screw 10 Bx 1/4"	6
*	9545-014-004	Bolt, 5/16-18 x 5/8"	8
*	8640-400-003	Nut, 5/16-18	8
*	9538-184-001	Spacer, Shaft	2
*	9487-234-005	Ring Tolerance.....	2
*	9125-007-001	Damper Inside Duct Exhaust	2
*	9125-007-002	Damper Inside Duct Exhaust	1
*	8520-141-000	Nut, Spring	4
*	9074-335-001	Cover Duct Lower	1
*	9545-008-024	Screw 10ABx 3/8"	72
*	9029-173-001	Bracket for Wire Harness Under Burner Housing	2

Rear View Photos

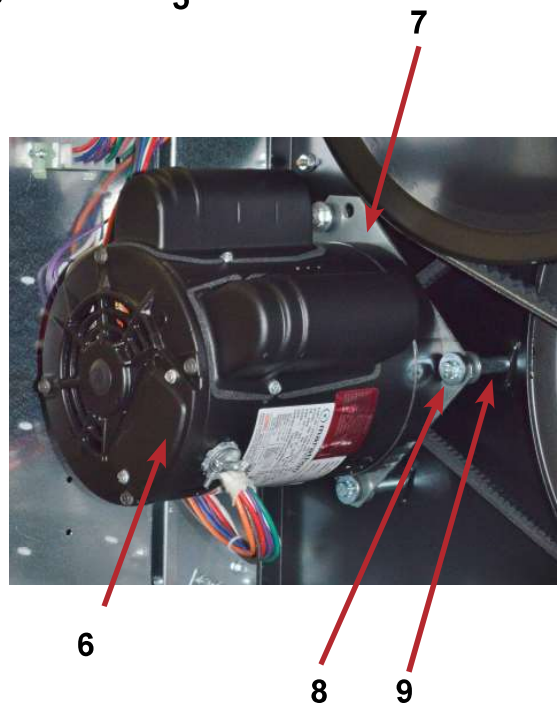
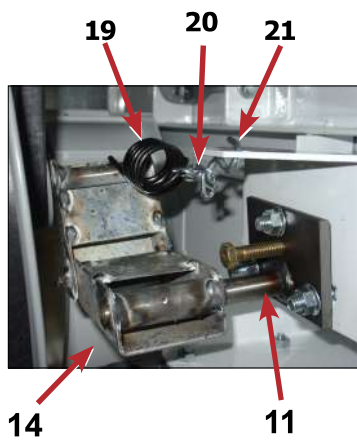
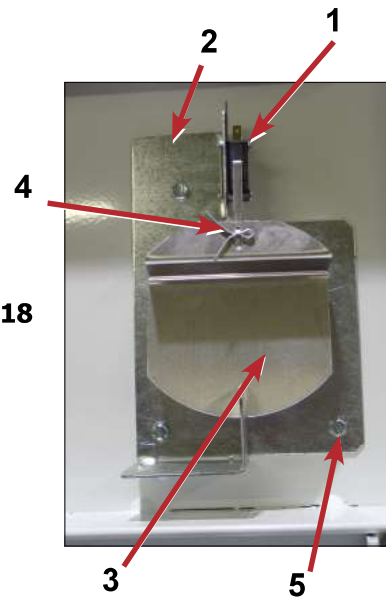
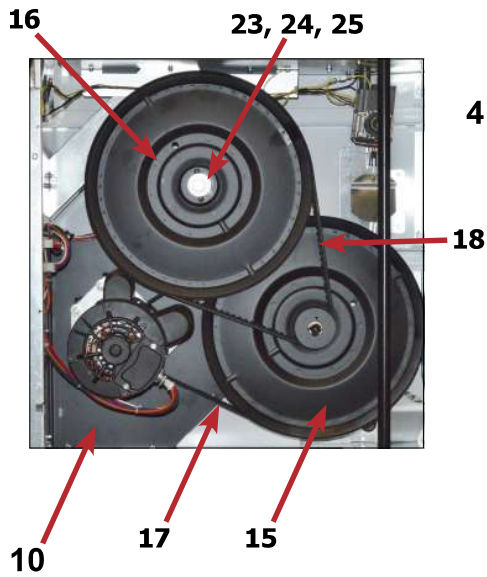
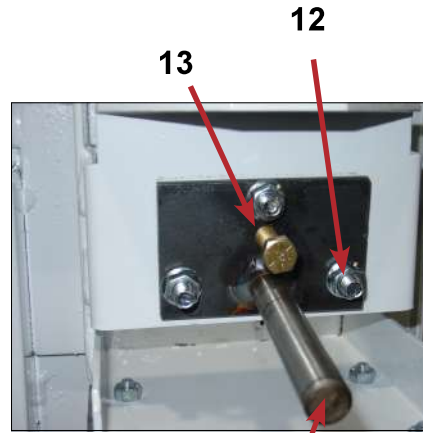

Rear Panel & Cover Group

Key	Part Number	Description	Quantity
1	9208-090-001	Rear Guard Side Panel 1.....	2
4	9545-008-024	Screws 10 AB x 3/8.....	30
5	8502-649-001	Label - Connection Electrical.....	1
8	9208-089-001	Rear Guard Back Panel.....	2
10	8502-600-001	Label Warning & Notice.....	1
11	8502-645-001	Label - Instructions.....	1
12	9109-113-001	Transition Assembly Outlet.....	1
13	9074-320-001	Top Cover Dryer Panel.....	1
14	9550-188-001	Top Burner Housing Heat Shield Inlet.....	1
15	9074-321-001	Top Panel Burner Housing Cover.....	1



1



8

Screws

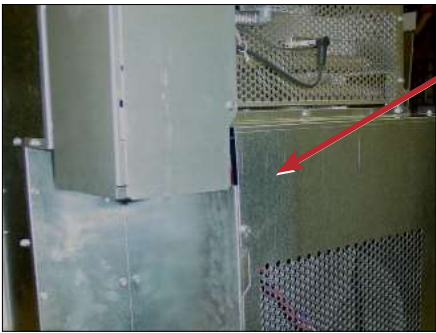

8

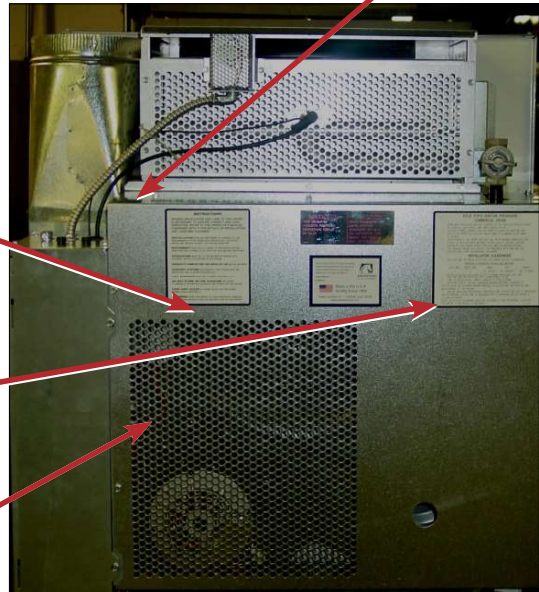

5

11

8

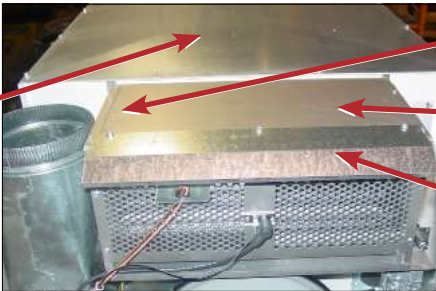

13

12

15

14

Tumbler Group

Key	Part Number	Description	Quantity
1	9848-148-001	Tumber Assembly Galvanized.....	2
*	9848-148-002	Tumbler Assembly Stainless Steel.....	2
*	9848-149-001	Tumbler Assembly Galvanized w/spider.....	2
*	9848-149-002	Tumbler Assembly Stainless w/spider.....	2
2	9568-013-001	Spider Assembly	2
3	9497-226-002	Rod, Tumbler	6
5	8640-417-005	Nut, 1/2 - 136
4	8641-590-002	Washer, Special	6
6	9552-013-000	ShimAR

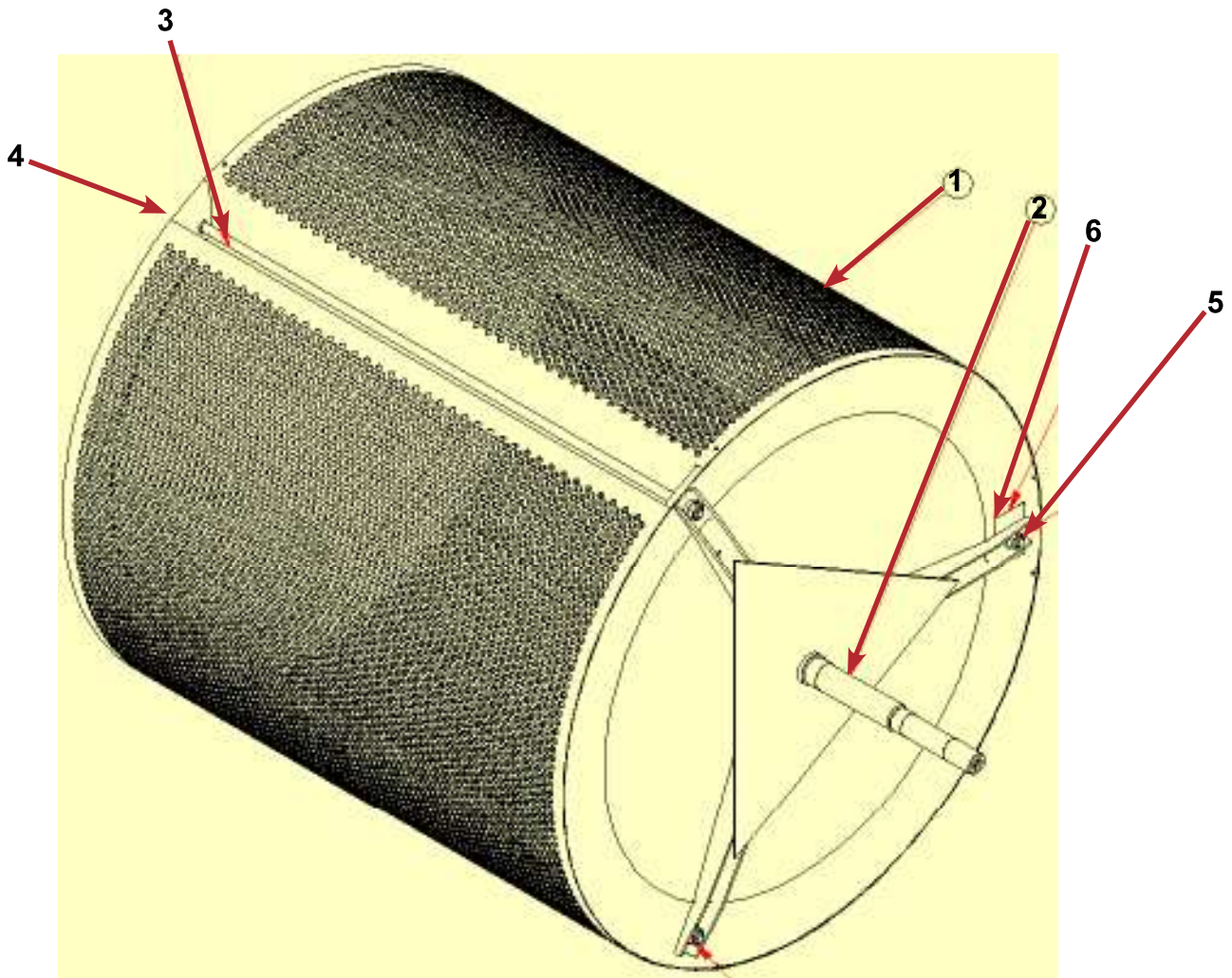

Control Assembly Group

Key	Part Number	Description	Quantity
*	9857-189-008	Control Assmby Complete (all below included)	1
*	9074-317-001	Control Box Cover	1
1	8653-068-003	Connector Conduit 3/8" STR.....	1
2	9558-031-001	Strip Terminal Marker (Behind Input Power) to above #3.....	1
3	9897-035-001	Terminal Block Assembly Main Power Inlet	1
*	9545-008-024	Screws 10AB x 3/8"	4
*	9627-859-003	Wire Harness - Power Main	1
4	8220-001-478	Wire Assembly Green 7"	1
5	9545-008-027	Screw # 10-32 x 12 Green	1
*	8641-582-006	Lockwasher Ext Tooth #10.....	1
6	9897-026-002	Terminal Block Main Power Middle	1
7	9897-026-001	Terminal Block.....	2
*	9545-045-012	Screw #8 ABx1 2 for terminal block	6
8	8711-013-001	Transformer Control.....	1
*	9545-008-024	Screws 10AB x 3/8"	4
9	9857-182-001	Ignition Control	2
*	9545-008-018	Screws 10AB x 3/4"	4
10	9631-403-009	Wire Assembly High Voltage Upper	1
11	9627-867-005	Wire Harness Ignition Control Upper	I
12	9631-403-008	Wire Assembly High Voltage Lower	1
13	9627-867-006	Wire Harness Ignition Control Lower	I
*	9053-067-002	Bushing Wire 7/8".....	4
14	9200-001-002	Fuseholder Assembly	3
*	8636-018-001	Fuse 1.5 Amp.....	2
*	8636-018-004	Fuee 2.5 Amp.....	1
15	5192-299-002	Relay Power	2
*	9545-045-012	Screws Power #8 AB x 1/2".....	4
*	8220-062-036	Wire Assembly Red/Black 14"	1
*	8220-062-037	Wire Assembly Red/White 14"	1
16	9627-864-006	Wire Harness Motor Extension.....	2
17	9527-007-001	Stand Off - Wire Saddle / Arrowhead	5
18	9627-863-001	Wire Harness Main Extension Access Under Burner Housing	4

Control Protection Fuse 2.5 Amp

Ignition Upper Pocket Protection Fuse 1.5 Amp

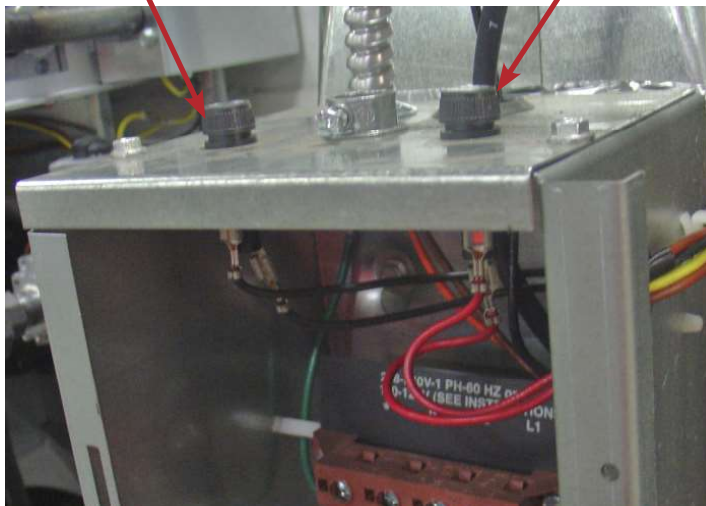

Not Shown:
24VAC Ignition
Lower Pocket
Protection Fuse

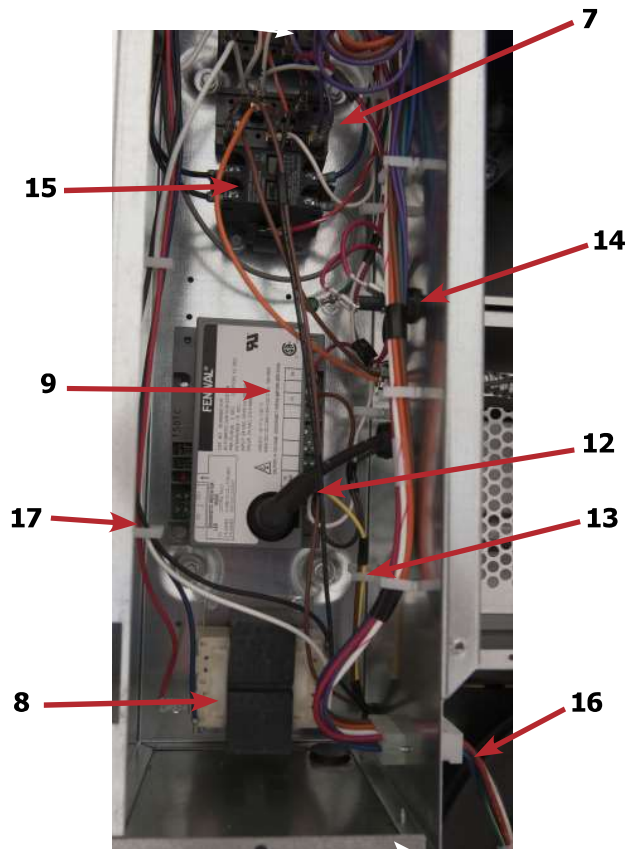
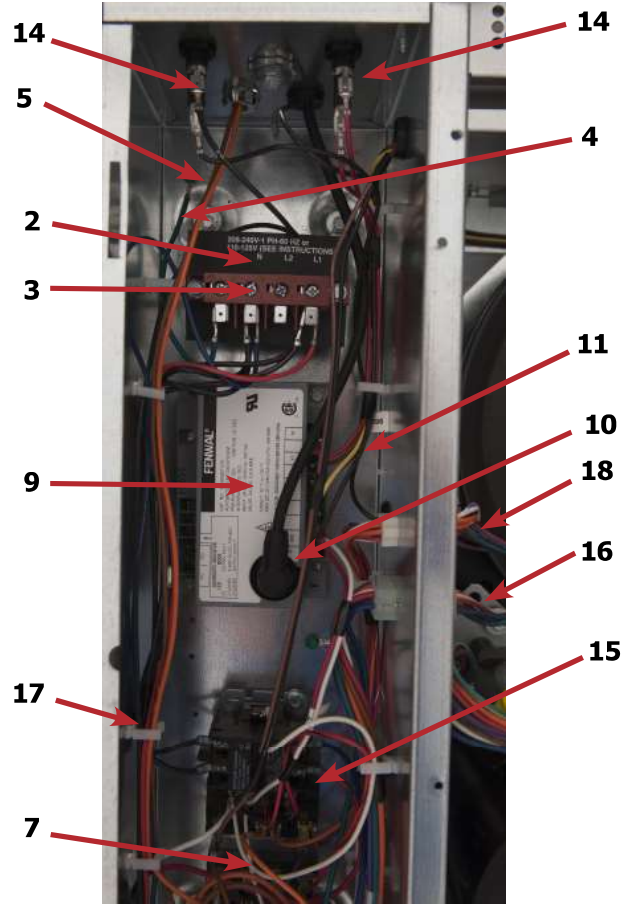
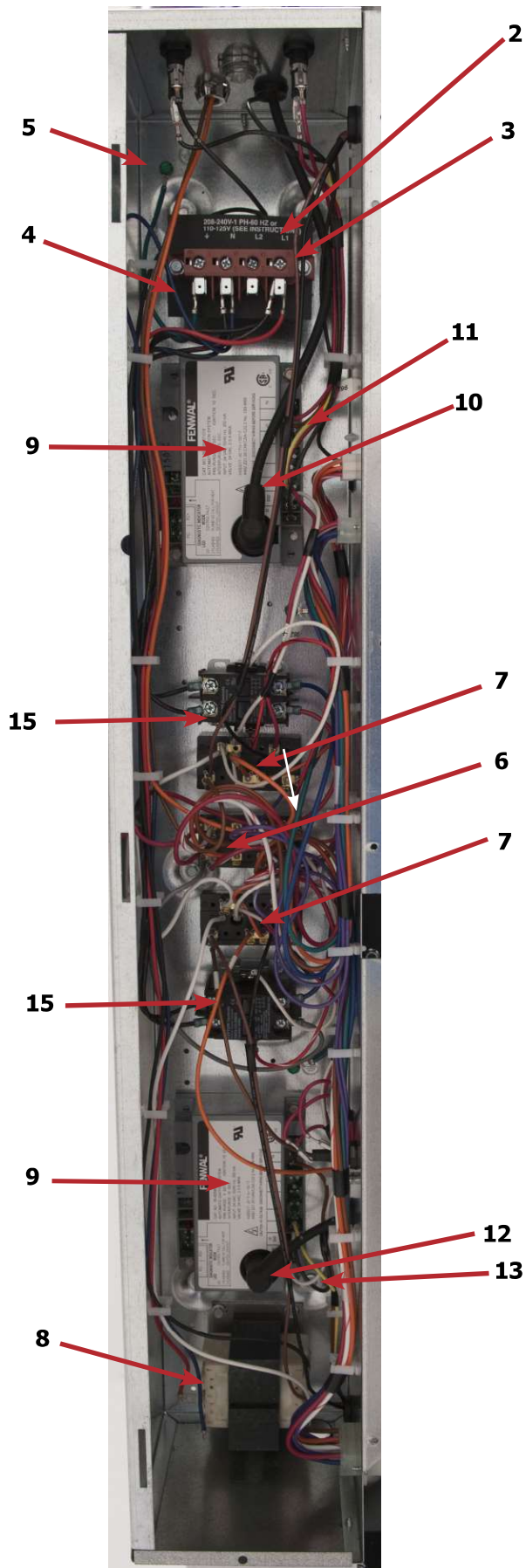

Coin Acceptor

Key	Part Number	Description	Quantity
1	9021-041-001	Coin Acceptor, Optical	1
2	9801-099-001	Sensor-Optical, Replacement.....	1
3	9545-039-002	Screw, Height Bar, 3mm.....	2
*	9486-136-001	Retainer, Coin Acceptor	1
*	9545-053-002	Screw	4

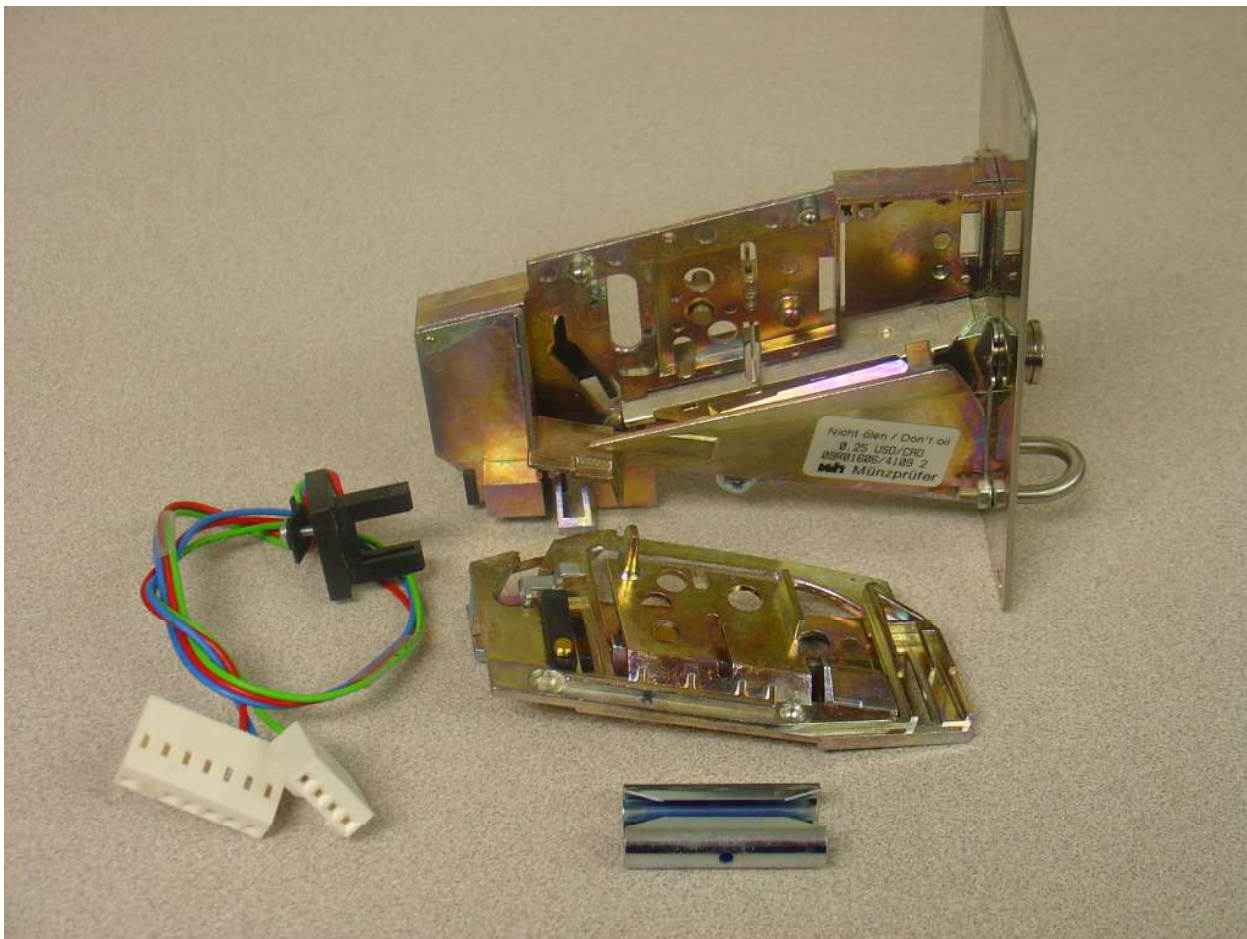

Wiring Schematic for DC50x2

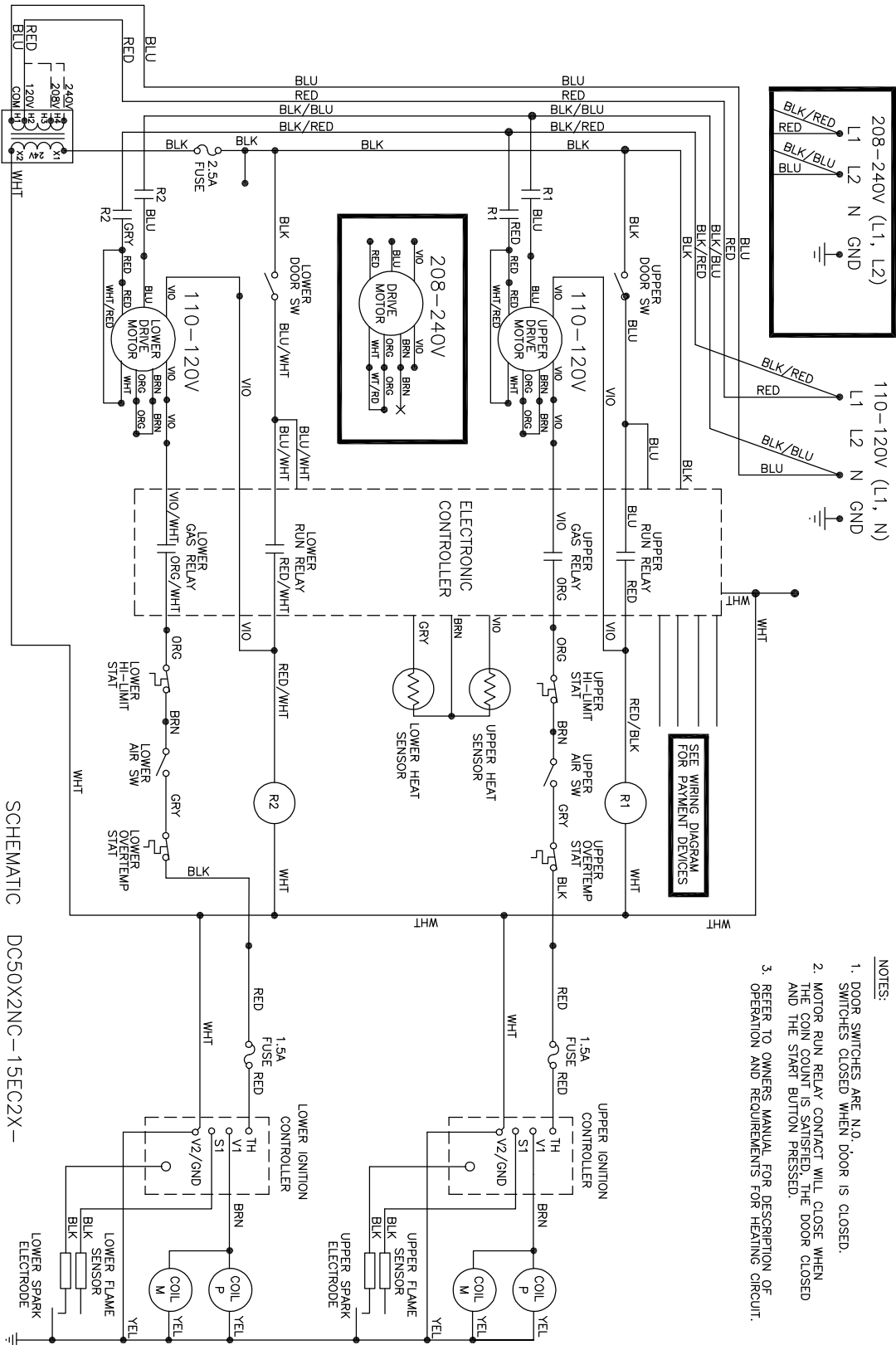

- NOTES:
1. DOOR SWITCHES ARE N.O. SWITCHES CLOSED WHEN DOOR IS CLOSED.
 2. MOTOR RUN RELAY CONTACT WILL CLOSE WHEN THE COIN COUNT IS SATISFIED, THE DOOR CLOSED AND THE START BUTTON PRESSED.
 3. REFER TO OWNERS MANUAL FOR DESCRIPTION OF OPERATION AND REQUIREMENTS FOR HEATING CIRCUIT.

IMPORTANT: RETAIN THIS ELECTRICAL SCHEMATIC FOR SERVICE.

SCHEMATIC DC50X2NC-15EC2X-
 9506-596-001 REV. B
 110-120/208-240V, 1 PHASE, 60 HZ

Wiring Diagram for DC50x2

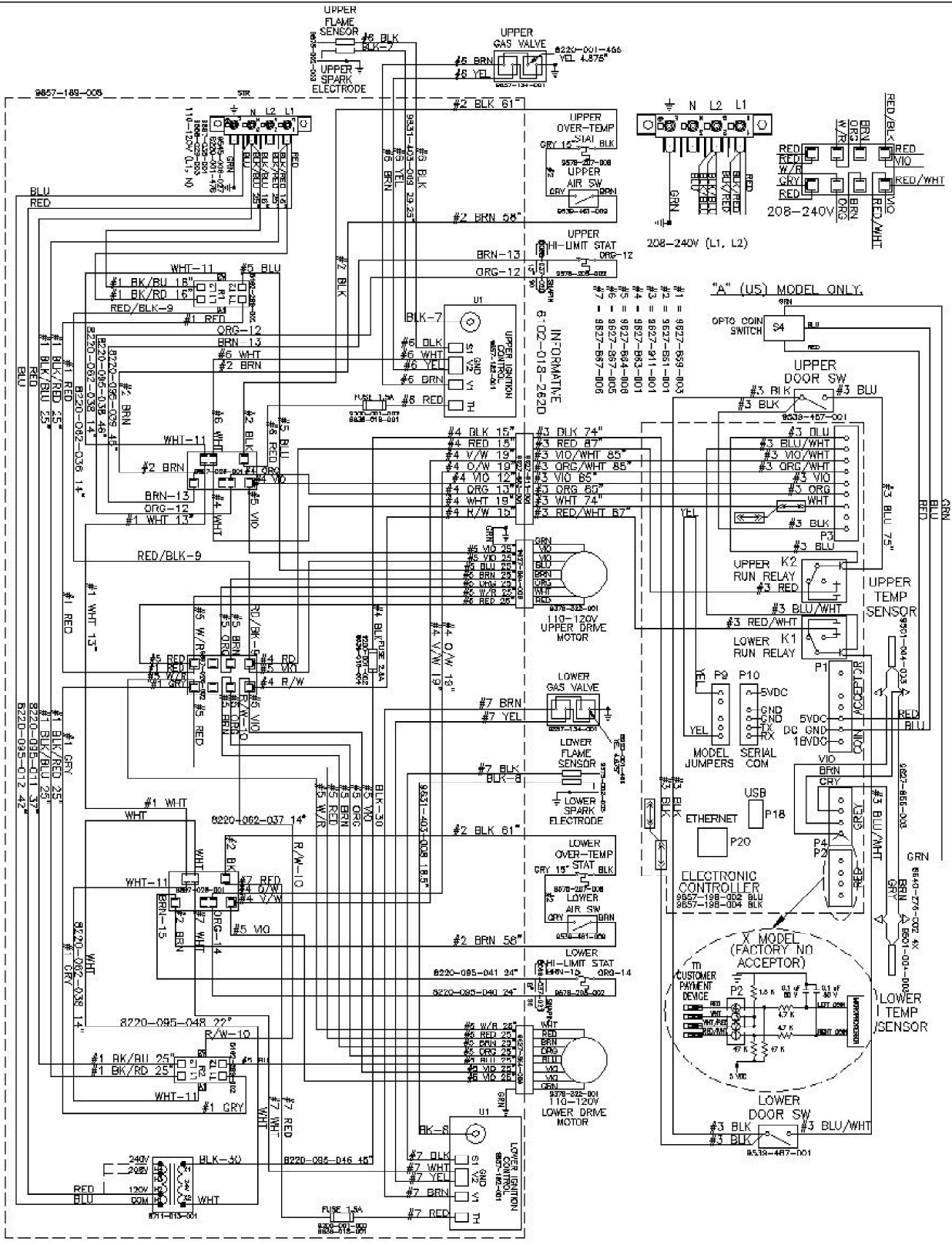

9506-596-001B WIRING DIAGRAM DC50X2NC-15EC2X-

