



Section: 7

Parts Data

DC30X2

120V Control

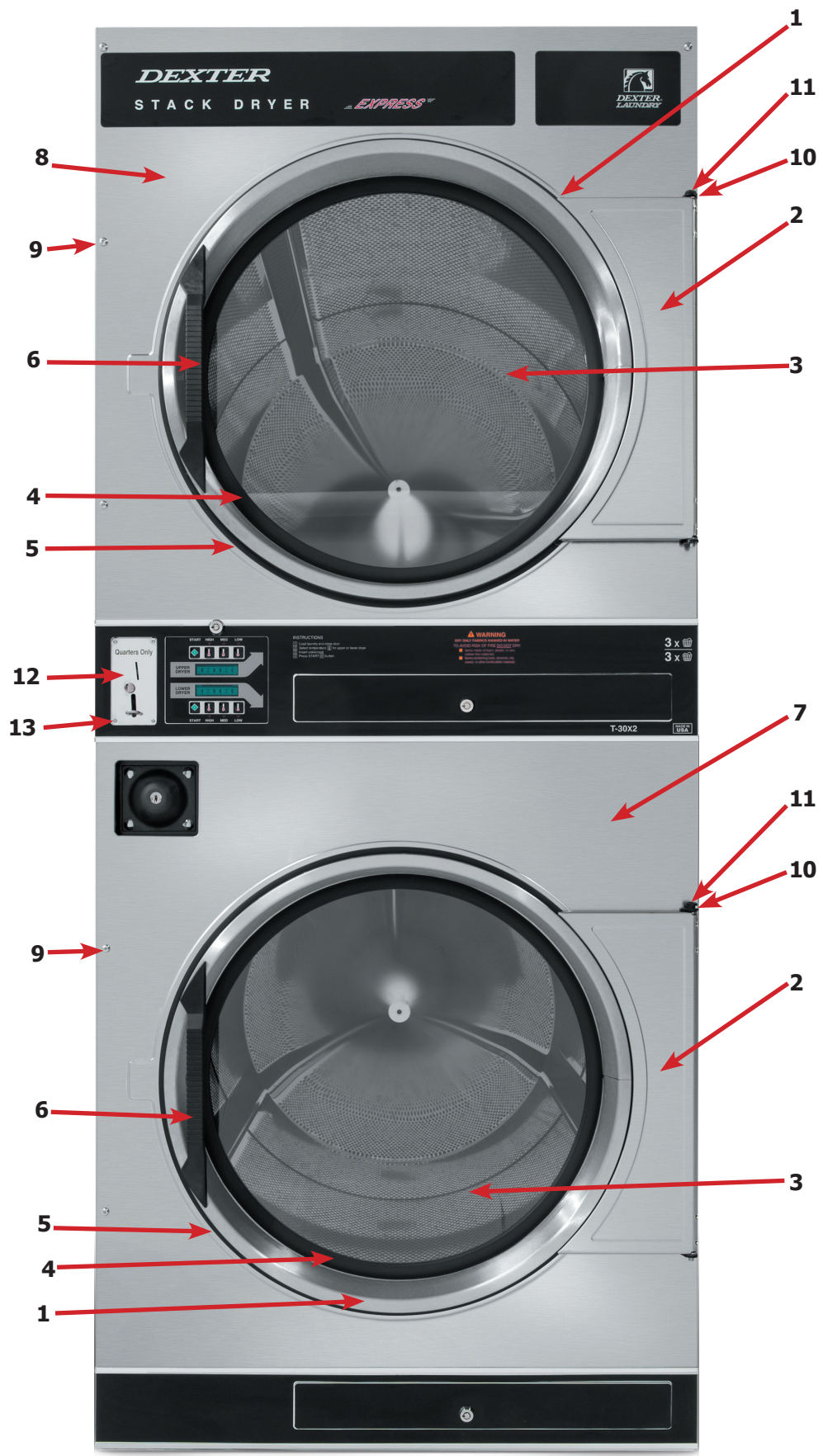

Parts Data

Cabinet Group

Key	Part Number	Description	Quantity
*	9960-256-032	Door Assy., Loading Complete-Wht	2
*	9960-256-034	Door Assy., Loading Complete-SS	2
*	9960-256-035	Door Assy., Loading Complete-Chrome SS/CHR/BLK	2
1	9960-255-008	Door Assy., Loading-SS(ring only)	2
1	9960-255-016	Door Assy., Loading-Chrome(ring only)	2
2	9982-280-014	Plate Assy., Hinge (Wht) No Pin	2
2	9982-280-012	Plate Assy., Hinge (SS) No Pin.....	2
*	9545-012-015	Screw, Hinge to Door	8
*	8640-413-002	Nut, Hinge to Door	8
3	9212-002-003	Glass, Door	2
4	9206-413-001	Gasket, Glass, Black.....	2
*	9548-117-000	Support, Door Glass	2
5	9206- 420-003	Gasket, Outer Rim Black.....	2
6	9244-082-001	Handle, Loading Door	2
*	9545-018-017	Screw, Handle 1/4-20 x 3/8	2
*	9531-033-001	Stud, Door Catch	2
*	8640-413-001	Nut, Hex	2
*	8640-413-003	Nut, Acorn	2
*	9086-015-002	Catch, Loading Door	2
*	8638-190-009	Pop Rivet for mtg. catch	4
*	8641-582-006	Lockwasher	4
*	8640-399-001	Spring Nut	6
7	9989-532-003	Panel Assy., Front- Lower (Wht) (LRG Vault).....	1
7	9989-532-001	Panel Assy., Front- Lower (SS) (LRG Vault).....	1
8	9989-513-003	Panel Assy., Front- Upper (Wht)	1
8	9989-513-001	Panel Assy., Front- Upper (SS)	1
9	9545-008-020	Screw, Torx HD 10 x 3/4.....	14
*	8541-582-019	Lockwasher	6
*	8640-399-001	Nut, Spring	12
10	9544-047-002	Strap, Hinge (Wht)	2
10	9544-047-007	Strap, Hinge (SS/Gray)	2
10	9544-047-011	Strap, Hinge (Chrome/Black)	2
*	9345-008-020	Screw, Hinge to Panel	8
11	9545-052-001	Screw, Door to Hinge Strap (Special Black Type)	2
*	8641-436-003	Washer, Fiber	2
12	9021-041-001	Acceptor-Coin, Optical	1
*	9486-149-001	Retainer, Coin Acceptor	2
13	9545-053-002	Screw	4
*	9801-099-001	Switch, Optical (Replacement)	1

Cabinet Group Continued

Key	Part Number	Description	Quantity
14	9994-030-001	Escutcheon, Upper	1
15	9435-037-002	Trim, Overlay-Upper, Blue	1
15	9435-037-001	Trim, Overlay-Upper, Black.....	1
*	9545-020-009	Screw, #4-40 x 3/16.....	10
16	9994-031-001	Escutcheon, Lower	1
17	9435-020-001	Trim, Overlay-Lower, Blue	1
17	9435-028-001	Trim, Overlay-Lower, Black.....	1
*	9545-020-009	Screw, #4-40 x 3/16.....	10
18	9412-167-002	Nameplate Stack Dryer Express, Blue1
18	9412-167-001	Nameplate Stack Dryer Express, Black1
19	8650-012-003	Lock and Key, Lint Drawer #6101	2
*	6292-006-010	Key 6101 only for Lint Drawer	AR
*	9095-043-001	Cam, Lock Lint Drawer2
*	9627-911-001	Harness, Main-Electronic Control1
20	9857-198-001	Controls Assy, Electronic Mounted With Membrane Switch, BLU... 1	1
20	9857-198-003	Controls Assy, Electronic Mounted With Membrane Switch, BLK... 1	1
21	9435-038-002	Overlay-Control, Blue	1
21	9435-038-001	Overlay-Control, Black	1
22	8650-012-003	Lock and Key, Control #6324	1
*	9095-041-001	Cam, Lock	1
*	6292-006-007	Key 6324 only for Computer.....	1
*	9150-045-001	USB, Thumbdrive.....	1
*	9627-855-001	Harness, Heat Sensor	1
*	8640-276-002	Wire Nut Connector Grey.....	4
23	9501-006-001	Sensor Temp Control (serial #200588).....	2
24	9486-137-002	Retainer - Push On.....	2
*	9209-037-002	Grommet, 3/16 ID	2
25	9866-004-001	Lint Drawer Assembly, Blue2
25	9866-004-011	Lint Drawer Assembly, Black2
26	9435-003-009	Overlay trim, lint drawer, Blue	1
26	9435-029-001	Overlay trim, lint drawer, Black.....	1
*	9532-074-003	Felt Seal (back of lint screen assembly)	2
*	9805-029-002	Lint Screen Assembly ONLY (no front)	2
*	9555-057-002	Replaceable Lint Screen Only2
*	9545-008-001	Screws 10Bx 1/4 Lint Screen Strap Hold Down	32
*	8544-006-001	Leg, Leveling 1/2"	4
*	9074-261-001	Cover, Cabinet (Top).....	1
*	9277-041-011	Insulation Cabinet Cover1
*	9732-253-001	DDAD Kit for Dryers without Neutral and using 208-240 volt	1
*	9732-102-011	LP Kit for DDAD Dryers.....	1
*	9555-057-003	Replaceable Lint Screen Fine Mesh Only1
*	9277-053-001	Insulation-Front Panel-Top Half	2
*	9277-053-002	Insulation-Front Panel-Lower Half.....	2
*	9527-007-001	Standoff Wire Saddle.....	8
*	9544-041-002	Strap - Bead Tie.....	1
27	9942-038-005	Vault, Coin Box	1
*	9545-008-024	Screws, Mounting-Coin Vault	2
28	9807-099-002	Coin Box Assy, Large Blue	1
28	9807-099-004	Coin Box Assy, Large Black	1

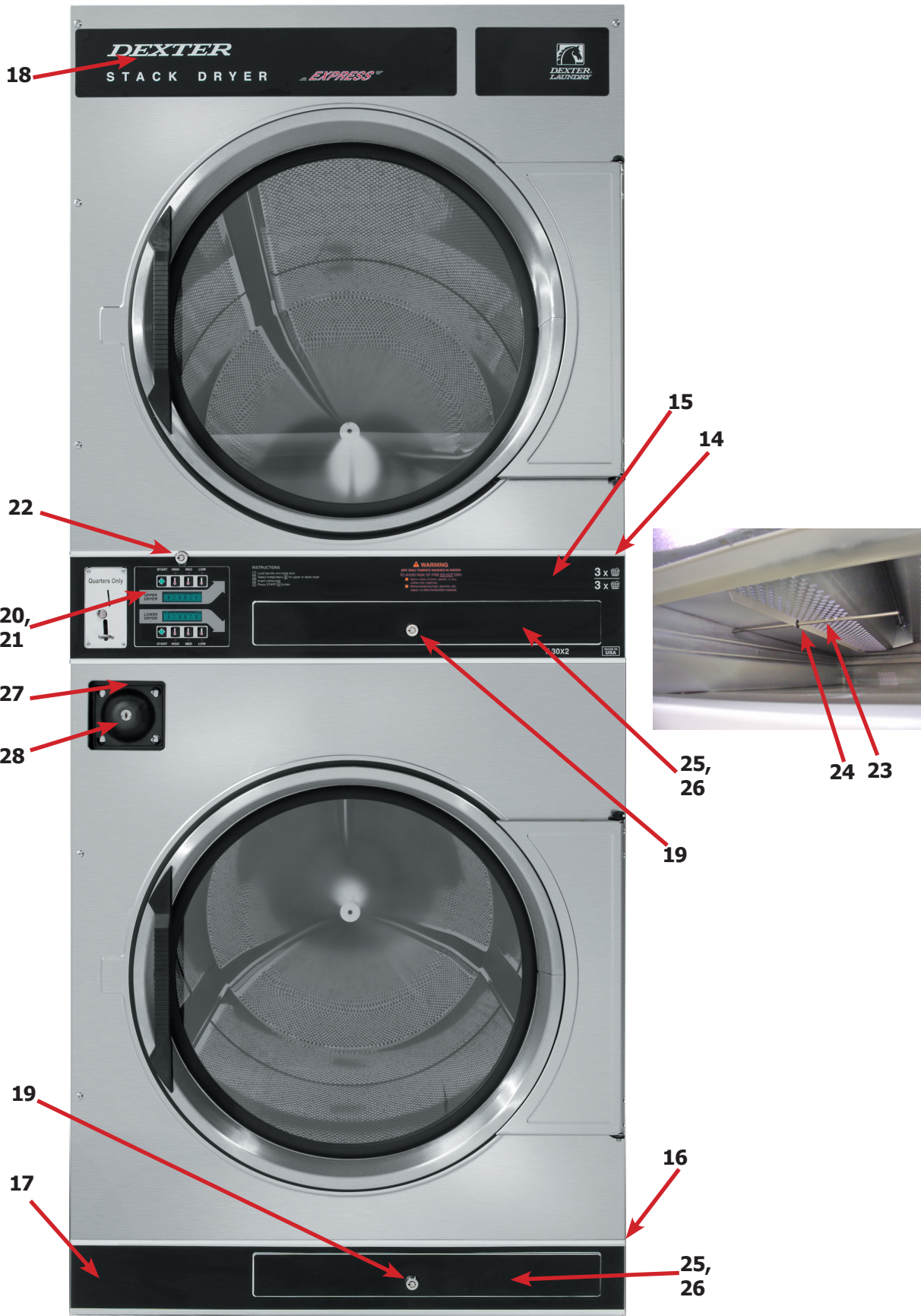

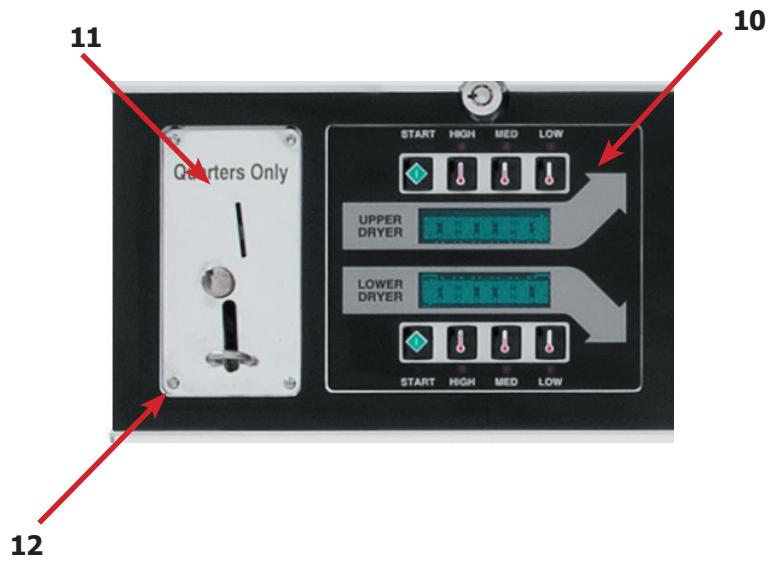
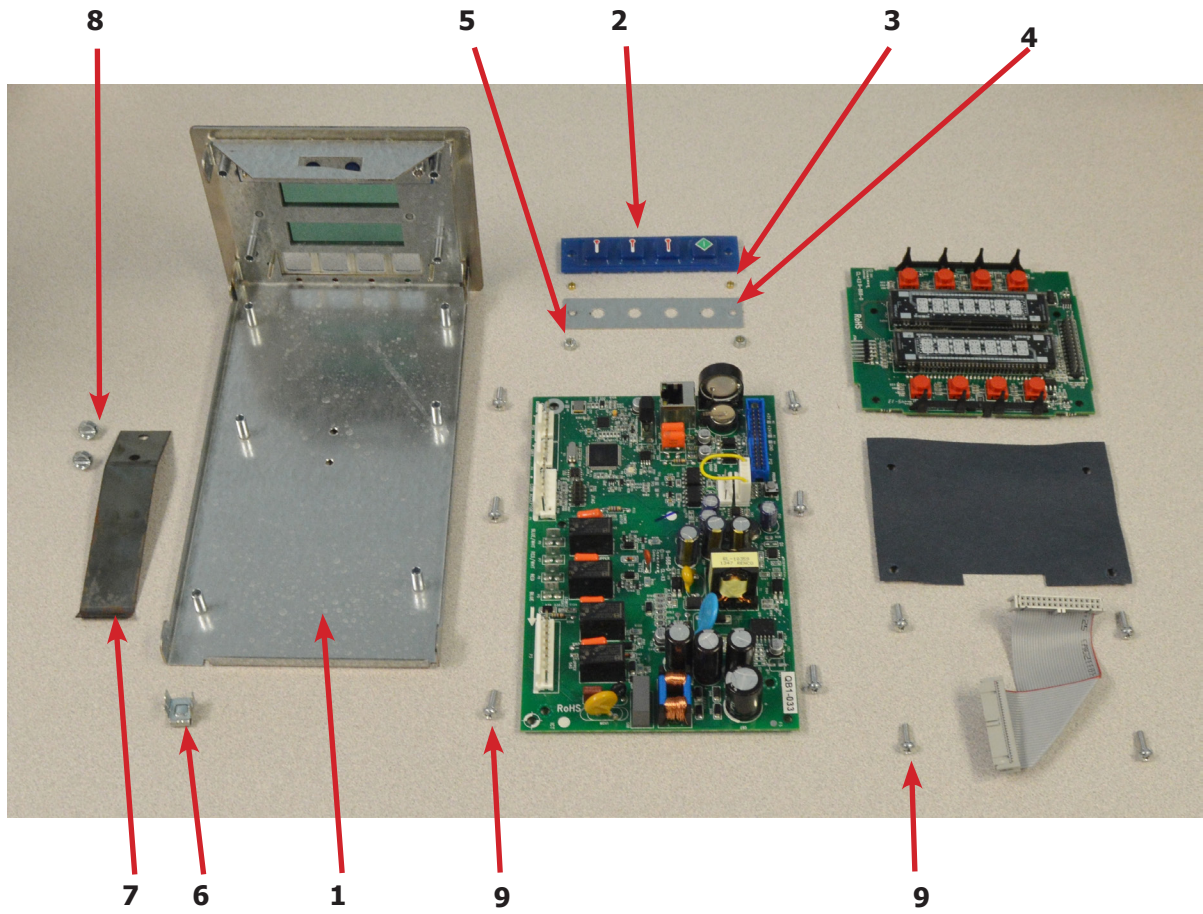

Control Parts Group

Key	Part Number	Description	Quantity
*	9857-198-001	Controls Assy, Electronic Mounted With Membrane Switch, BLU...	1
*	9857-198-003	Controls Assy, Electronic Mounted With Membrane Switch, BLK...	1
1	9826-008-001	Trough Assembly	1
2	9035-062-002	Button-Push, Control, Black	2
2	9035-062-001	Button-Push, Control, Blue.....	2
3	9538-166-011	Spacer-Metal, 4mm	4
4	9486-158-001	Retainer-Push Button	2
5	8640-424-002	Nut-Hex, Elastic stop, #4-40	4
6	8652-130-038	Terminal-Grounding clip	1
7	9534-365-001	Spring-Flat, Control	1
8	9545-008-0im		
01	Screw-Hex, #10B x 1/4	2	
9	9545-044-010	Screw-Hex, #10B x 1/4	10
9	8641-582-005	Washer-External tooth, #6	10
10	9435-038-001	Overlay-Control, Coin, Black	1
10	9435-038-002	Overlay-Control, Coin, Blue	1
11	9021-041-001	Acceptor-Coin, Optical	1
*	9486-136-001	Retainer, Coin Acceptor	1
12	9545-053-002	Screw	4
*	9801-099-001	Optical Sensor, Replacement.....	1
Note: Jumpers required if using 1.5 Control on Older Machines (P9 Connection)			
*	8220-155-001	Wire Assy, Jumper, 30Lb Stack Coin	1
*	8220-155-002	Wire Assy, Jumper, 50Lb Stack Coin	1

Hinge Plate Cover

1	9074-341-002	Cover-Hinge, Black	2
		Note: Before Serial # 220625 Holes can be drilled in hinge plate to install (#18 Drill bit).	
2	8636-018-017	Screw-TRHDCR, 10B x 3/8, Black.....	4

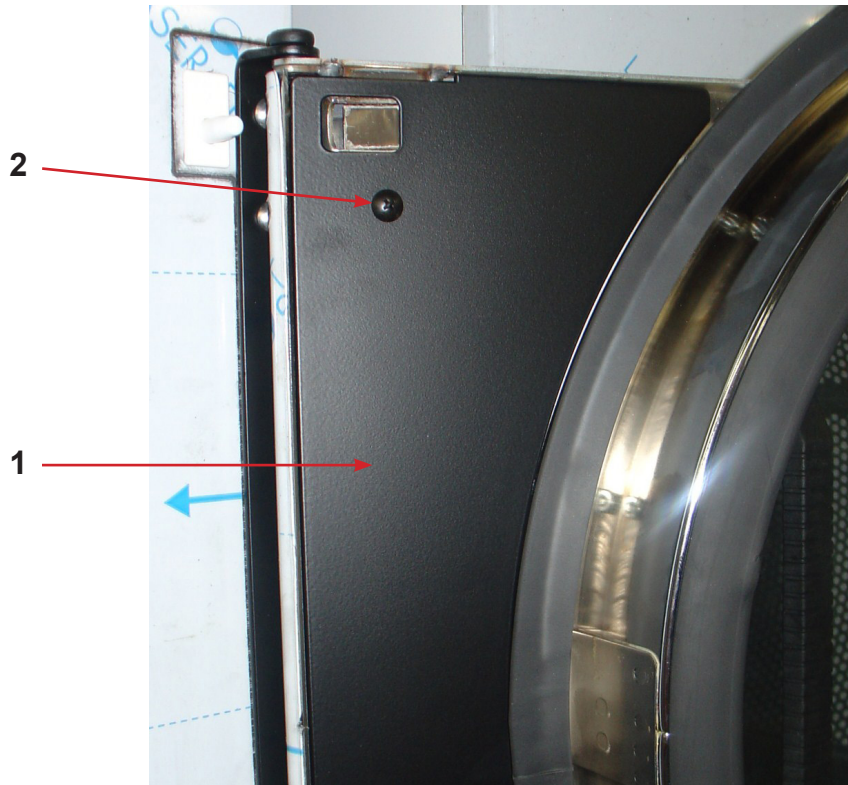

Door Switch Group

Part Number	Description	Quantity
9539-487-001	Door Switches	2



Bearing Housing Group

Key	Part Number	Description	Quantity
*	9803-160-003	Bearing Housing Complete Assy (Includes bearings & Spacer).....	1
1	9241-161-002	Housing, Bearing.....	1
*	9036-130-001	Bearing, Ball, Front	1
*	9538-139-002	Spacer, Bearing	1
2	9036-130-001	Bearing, Ball, Rear	1
3	9545-049-002	Screw-Wizlock, 3/8-24x3/4	4
4	8640-400-002	Nut, 5/16-18.....	4
5	9545-049-001	Screw, 3/8-24x1.....	2
6	8640-415-002	Nut, 3/8-24.....	2
*	9538-139-002	Shim, Tumbler	AR

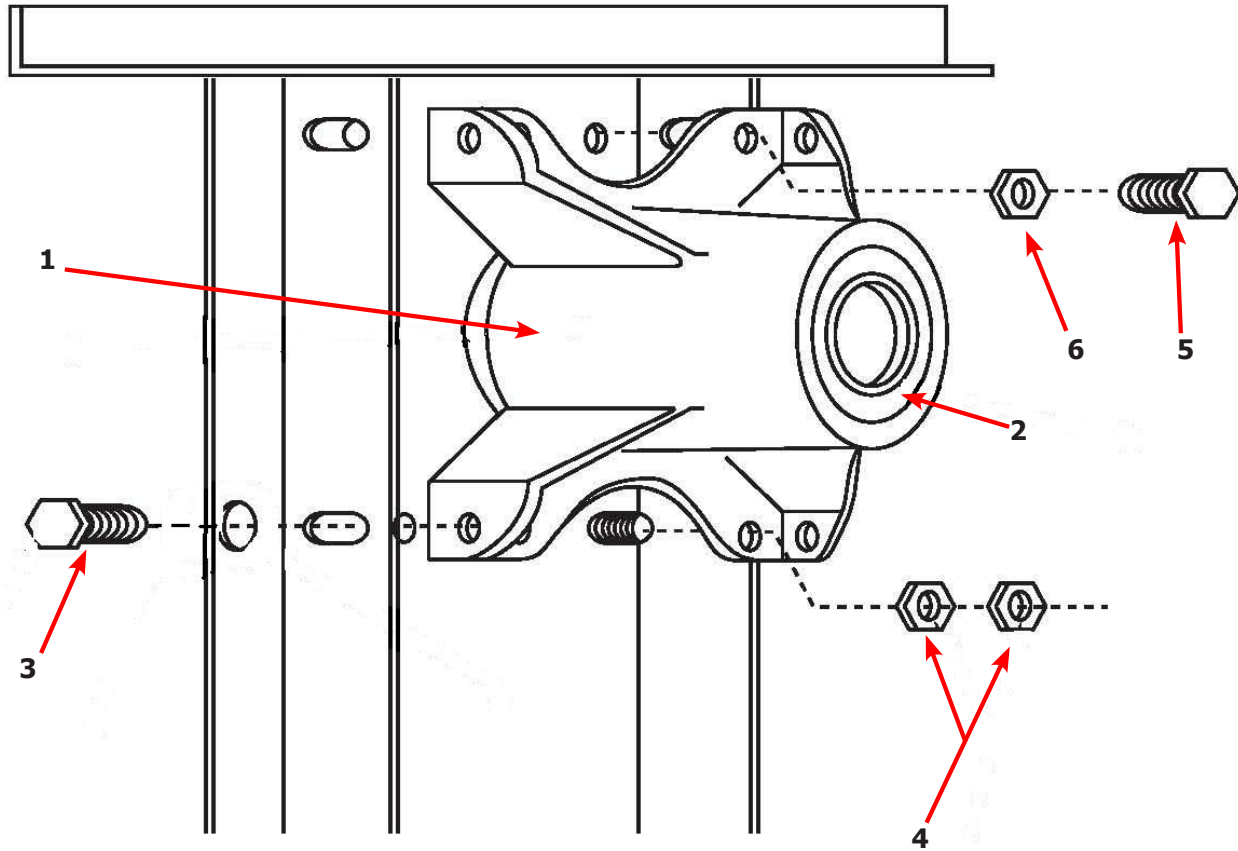

Tumbler Group

Key	Part Number	Description	Quantity
*	9848-147-001	Tumbler Assy Complete W/Spider (GALV).....	1
*	9848-147-002	Tumbler Assy Complete W/Spider (SS & Galv front).....	1
1	9848-146-001	Tumbler Assy (Galvanized).....	1
1	9848-146-002	Tumbler Assy (Stainless Galvanized front).....	1
2	9497-019-003	Rod, Tumbler.....	3
3	8641-554-001	Washer, Special.....	3
4	9552-013-000	Shim.....	AR
5	9568-015-001	Spider Assy.....	1
6	8640-415-004	Nut, Wiz Lock.....	3
7	9538-164-002	Spacer-Shaft.....	1
8	9487-234-005	Tolerance Ring.....	1
9	9908-049-002	Pulley, Driven.....	1
10	8641-581-026	Washer -Flat.....	1
11	8641-582-016	LockWasher - IntTooth, 1".....	1
12	9545-017-009	Screw, 1/2-13x1 1/4.....	1

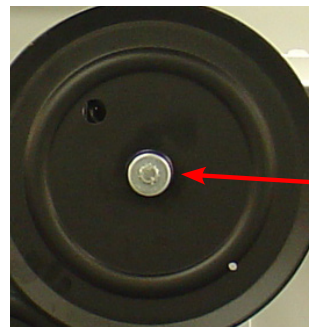
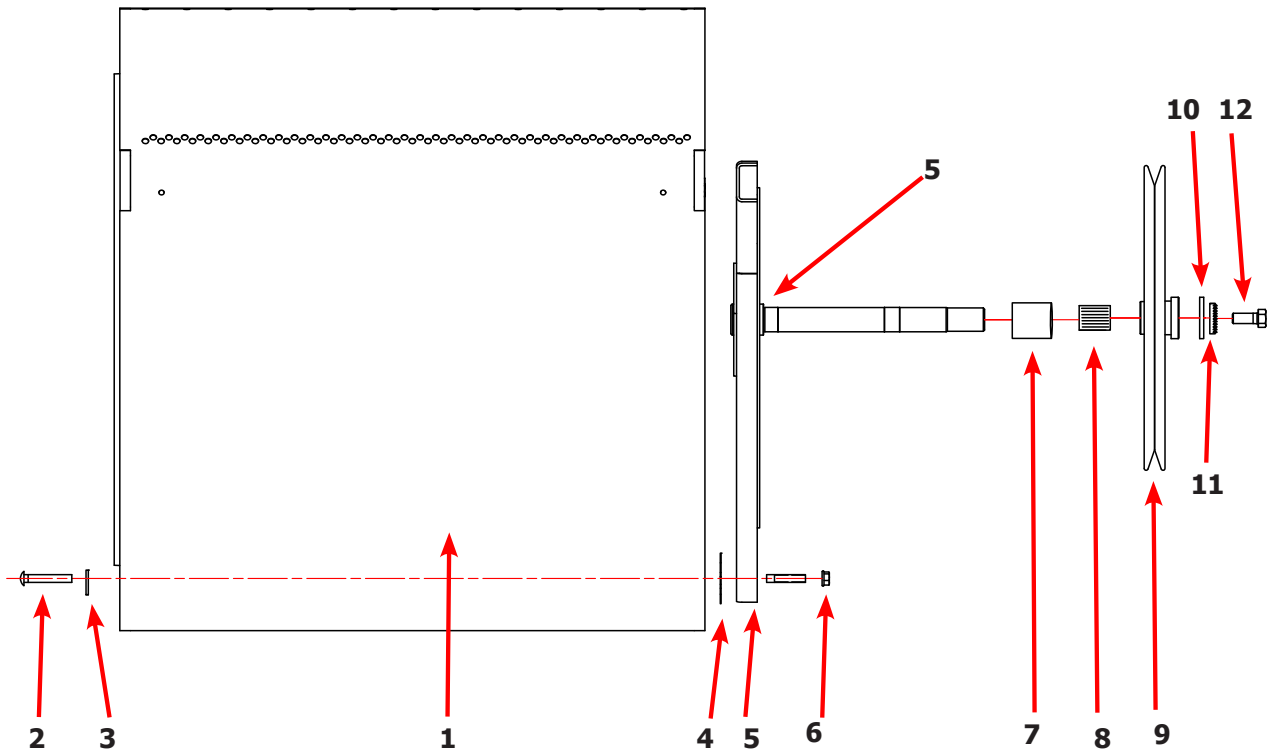

Burner Housing Group

Key	Part Number	Description	Quantity
*	9803-199-001	Housing Assembly, Burner (1 thru 7)	.2
1	9454-831-001	Panel-Burner Front & Bottom	2
2	9454-789-001	Panel-Burner, Side LH	2
3	9454-790-001	Panel-Burner, Side RH	2
4	9049-080-001	Baffle-Burner	2
5	9454-791-001	Panel-Burner, Top	2
6	9074-307-001	Cover-Burner, Top	2
7	9828-015-001	Connector Assembly-Burner	2
*	9545-008-001	Screws-#10B X 1/4	8
*	9545-008-006	Screws-#10AB x 3/8	46
8	9452-729-001	Service Plate baffle Recirculation Chamber Clean Out	2
9	9545-008-001	Screw-#10B X 1/4	16
10	9003-220-001	Angle, Burner Support	2
11	9048-020-001	Burner, Main	4
*	9545-008-001	Screw 10B x1/4"	.8
12	9452-730-001	Service Burner Plate Front	2
13	9545-008-001	Screw 10B x1/4"	.8
14	9029-192-001	Bracket-High Limit	2
*	9538-142-001	Spacer, Hi-Limit	4
*	9545-045-007	Screw 8B x 3/4"	4
15	9576-203-002	Thermostat, Hi-Limit	13
16	9074-329-002	Cover, Hi-Limit Stat	
17	9875-002-003	Electrode Assy, Ignition	2
*	9545-045-001	Screw, Electrode Mtg 8B x 1/4"	4
18	9857-134-001	Control Assy, Gas	2
19	9381-012-001	Manifold, Assy	2
*	9425-069-023	Orifice, Burner-Natural #125	4
*	9425-069-024	Orifice, Burner-LP #49	4
20	9029-047-001	Bracket, Manifold	.2
21	8615-104-038	Pipe Plug in end of Burner Manifold	2
22	9576-207-008	Thermostat, Safety Shutoff	2
*	9545-008-006	Screw	4
23	9825-061-001	Cover, Safety Stat	2
*	9732-102-011	Kit, LP Conversion DDAD Kit	.2
*	8665-073-045	Nipple 1/2" x 2 Black	2
24	9838-018-001	Welded One Piece Gas Pipe Assembly	1
25	9379-196-001	Valve, Gas Shut Off	1

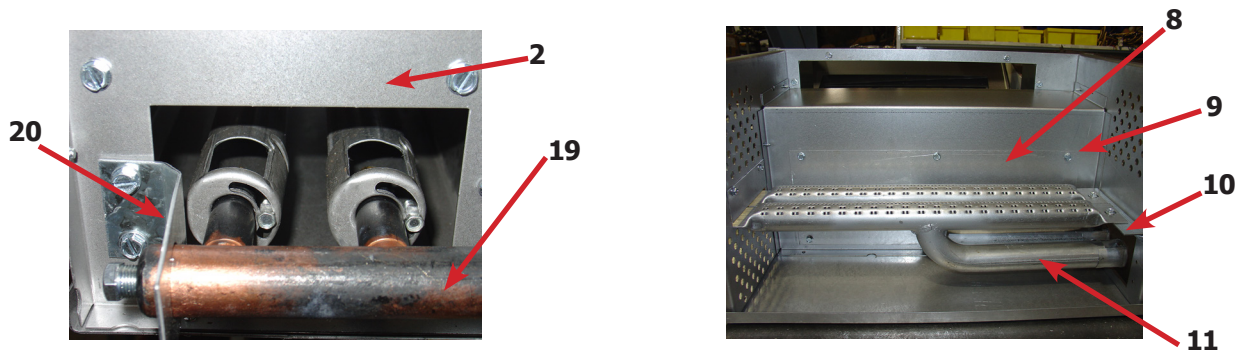

Burner Housing Group Photos

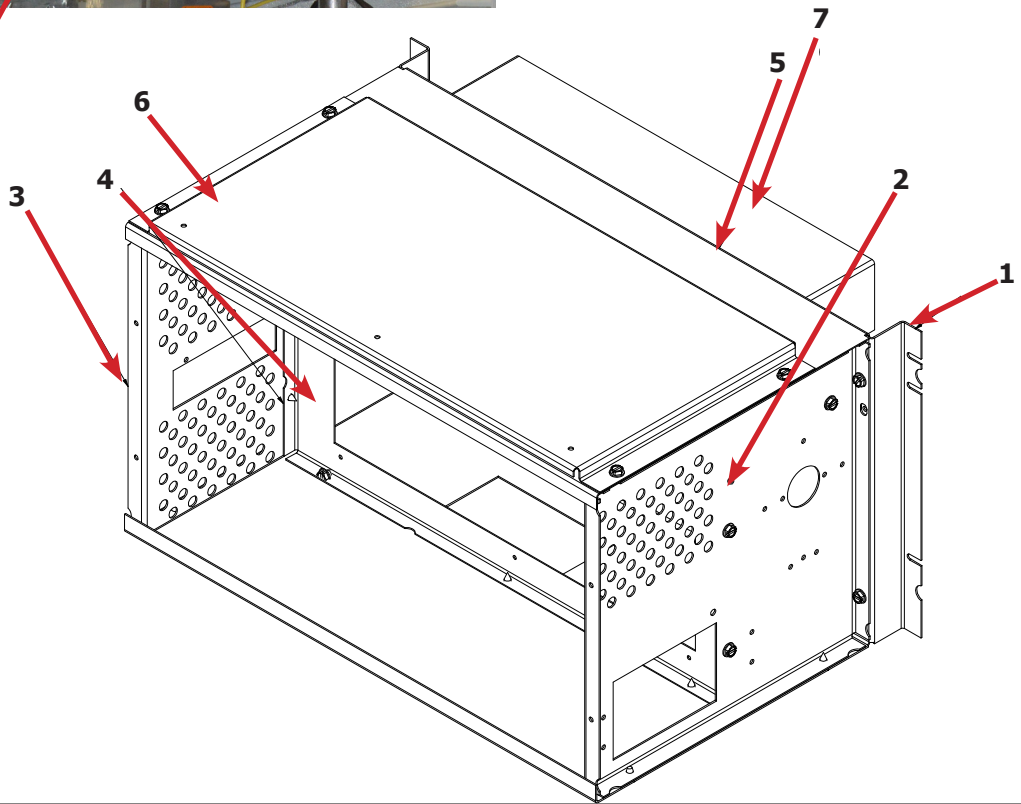
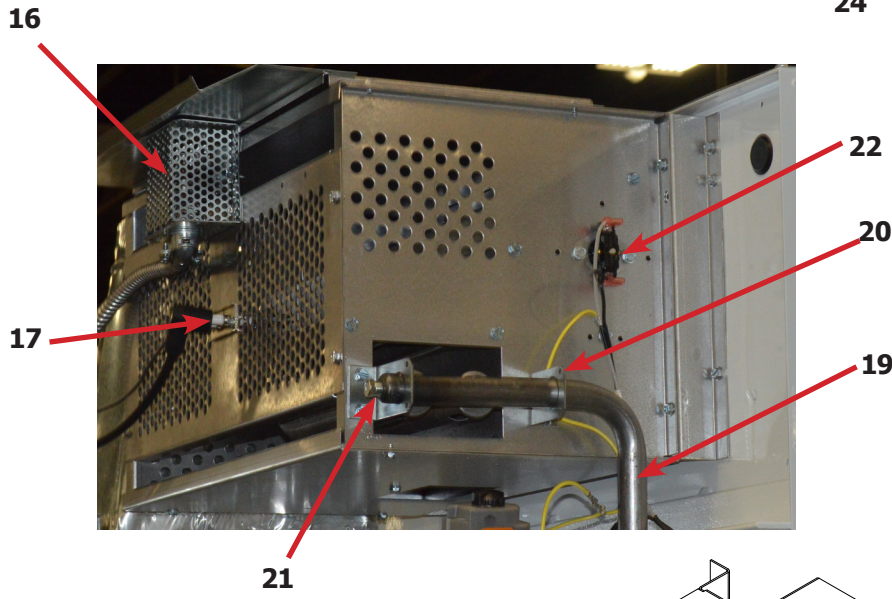
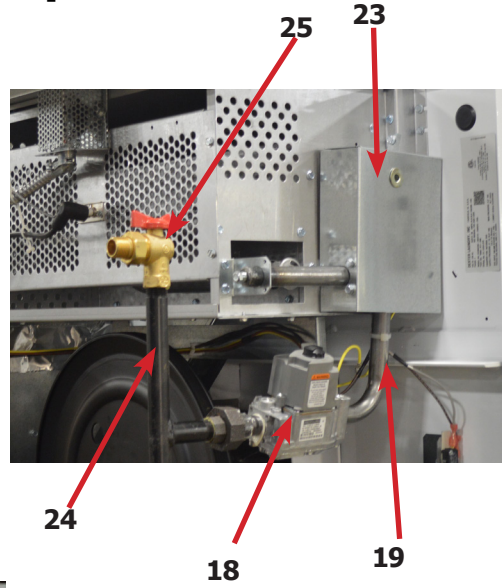
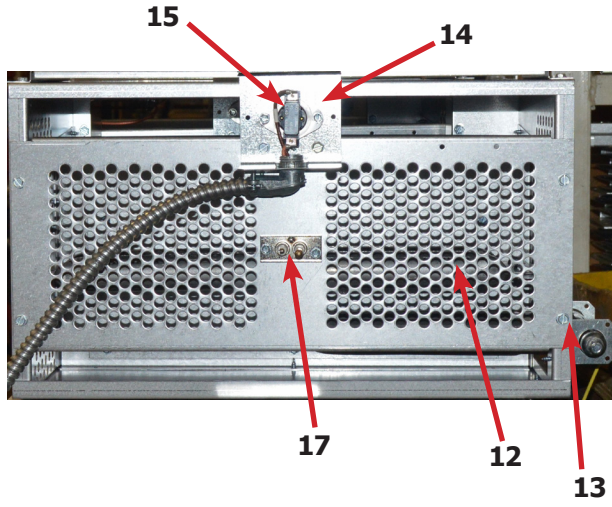

Rear View

Key	Part Number	Description	Quantity
*	9627-861-001	Wire Harness Overtemperature Switch	2
*	9801-095-001	Switch Assy, Air Flow	2
1	9539-461-009	Switch, Air Flow	2
2	9029-174-001	Bracket, Switch- Air Flow	2
3	9008-007-001	Actuator, Switch.....	2
4	9451-169-002	Pin, Cotter.....	2
5	9545-020-001	Screw 4-40 x 5/8".....	4
*	8640-401-001	Nut, Special Twin .#4-40	2
*	9550-169-003	Shield, Switch	2
*	9545-008-001	Screw 10 Bx 1/4"	6
7	9376-309-003	Motor, Drive	2
8	9452-740-001	Plate, Motor Mtg	2
*	9545-029-008	Bolt 3/8" - 16 x 3/4"	8
*	8641-582-003	Lockwash Spring 3/8.....	8
9	9545-018-019	Screw, Motor Plate to Back Assy. 1/4-20x 2 1/2.....	8
9	86411-582-007	Lockwasher 1/4	8
9	9538-,163-006	Spacer	8
9	8641-581-017	Flat Washer 1/4 x 7/8.....	8
9	9209-086-002	Rubber Grommet	8
*	9538-166-006	Grommet Spacers	8
27	9453-157-001	Pulley, Motor	2
*	9545-028-013	Screw, Set.....	4
10	9962-017-002	Back Assy, Blower Hsg	2
26	9278-040-001	Impeller, W/Set Screws	2
11	9991-053-001	SupportAssy, Intermed. Pulley.....	2
12	9545-029-010	Bolt, Rd Hd 3/8-16 x 1 1/4	6
13	9545-029-003	Bolt, 3/8-16 x 1 1/2	2
12	8640-415-004	Nut Flange Wizioc 3/8" - 16.....	6
12	8641-581-035	Washer, Flat	6
14	9861-022-001	Arm Assy-Tension, Complete.....	2
*	8641-581-035	Washer, Flat	2
15	9487-200-003	Ring-Retaining	6
16	9908-039-004	Pulley Assy, Intermediate with bronze flange bearing.....	2
*	9036-145-002	Bearing - Bronze Flange	4
*	9538-164-002	Spacer-Shaft (See Tumbler Group for Expandrd View)	1
*	9487-234-005	Tolerance Ring.....	1
17	9908-049-002	Pulley, Driven	1
18	8641-581-026	Washer -Flat.....	1
18	8641-582-016	LockWasher - IntTooth, 1".....	1
18	9545-017-009	Screw, 1/2-13x1 1/4	1
19	9040-077-001	Belt, Drive- Motor	2
20	9040-073-009	Belt, Drive- Tumbler	2
21	9534-319-002	Spring, Tension.....	2
22	9099-012-002	Chain, Tension	2
23	9248-,022-002	Hook, Tension	2
*	9125-005-001	Damper Inside Duct Exhaust	2
24	9451-146-001	Pin, Damper Hinge.....	2
*	8520-141-000	Nut, Spring.....	4
*	9545-008-026	Screw #10B x 1/2	6
25	9825-059-001	Cover Duct Upper	1
*	9074-314-001	Cover Duct Lower	1
*	9545-008-024	Screw 10ABx 3/8".....	80
25	9973-030-001	Heat Recirculation Assembly Duct	2
27	9453-157-001	Motor Pulley - Driver	1
*	9029-173-001	Bracket for Wire Harness Under Burner Housing	2

Rear View Photos

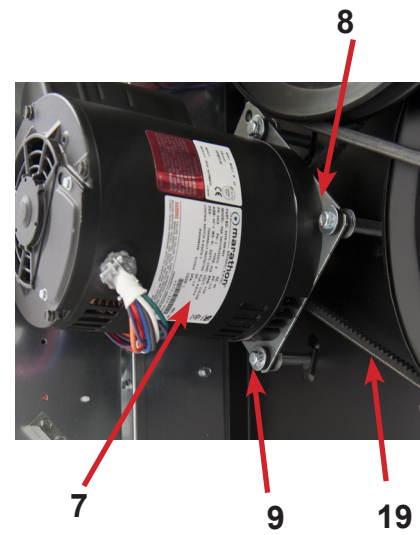
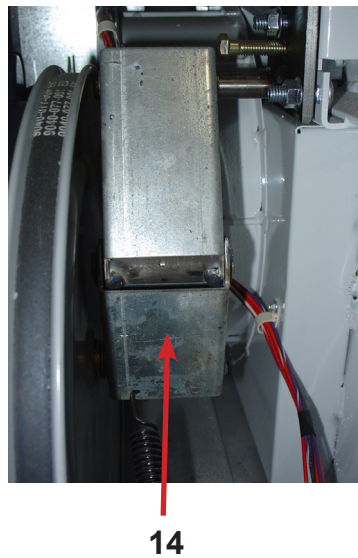
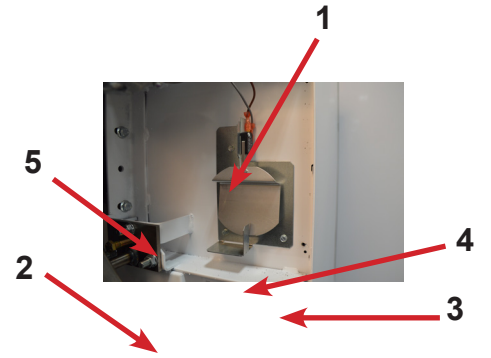
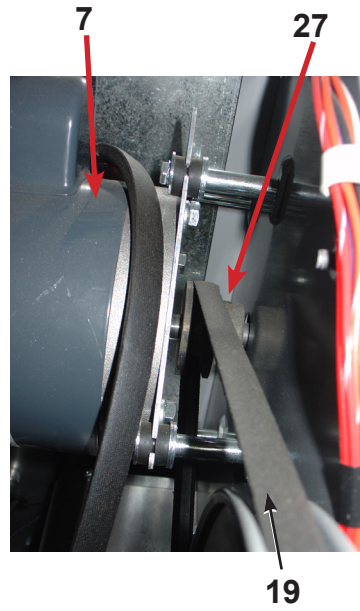
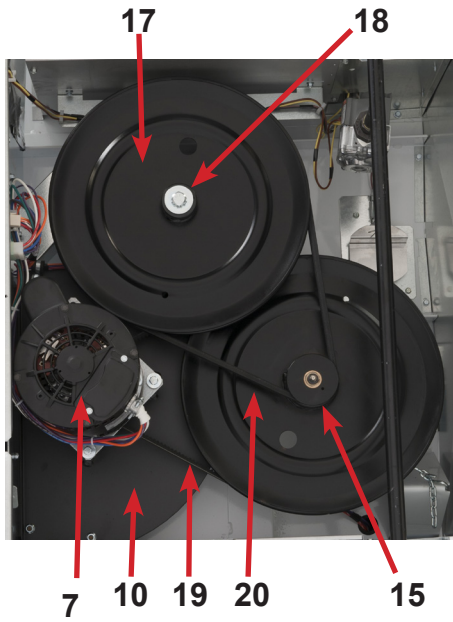
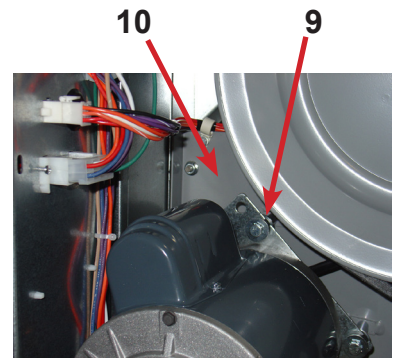
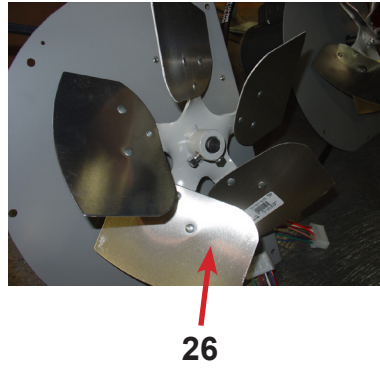
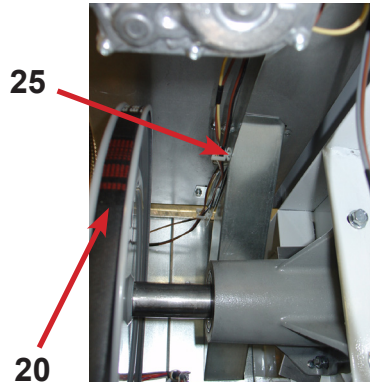

Rear Panel & Cover Group

Key	Part Number	Description	Quantity
1	9208-083-001	Back Drive Guard Panel after serial#200860	2
2	9208-076-001	Back Side Guard Panel Ass'y	2
*	9074-261-001	Cabinet (TOP COVER)	1
*	8544-006-001	Legs Leveling.....	4
4	9108-117-001	Electric Box Cover	6
5	9545-008-024	Screws 10 AB x 3/8	4
6	9109-113-001	Top Duct w/ Round	1
7	9074-364-001	Lower Duct Cover / Board.....	1

6

4

5

7

1

1

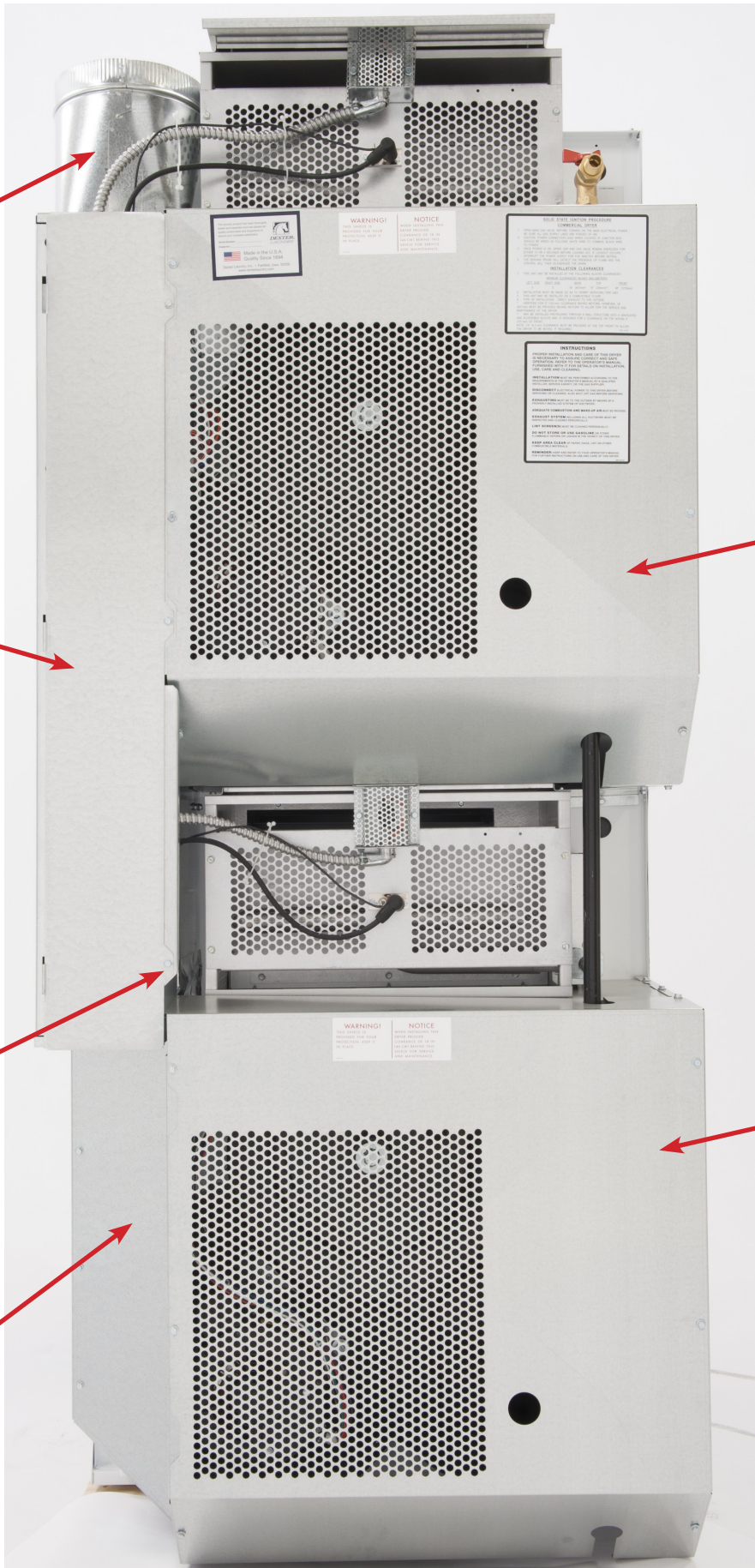

Control Assembly Group

Key	Part Number	Description	Quantity
*	9857-169-001	Control Assmby Complete (all below included)	1
*	9074-317-001	Control Box Cover	1
1	8653-068-003	Connector Conduit 3/8" STR.....	1
2	9558-031-001	Strip Terminal Marker (Behind Input Power) to above #3.....	1
3	9897-035-001	Terminal Block Assembly Main Power Inlet	1
*	9545-008-024	Screws 10AB x 3/8"	4
*	9627-859-001	Wire Harness - Power Main	1
4	8220-001-478	Wire Assembly Green 7"	1
5	9545-008-027	Screw # 10-32 x 12 Green	1
*	8641-582-006	Lockwasher Ext Tooth #10.....	1
6	9897-026-002	Terminal Block Main Power Middle	1
7	9897-026-001	Terminal Block.....	2
*	9545-045-012	Screw #8 ABx1 2 for terminal block.....	6
8	8711-011-001	Transformer Ignition.....	2
9	9545-031-005	Screw 6 B x 3/8"	4
10	9982-348-001	Plate Assembly MTG Ignition Control.....	2
11	9545-008-001	Screws 10B x 1/4" MTG Above Plate.....	4
12	9857-116-003	Ignition Control	2
13	9545-008-024	Screws 10AB x 3/8"	4
*	8640-411-003	Nut,#6-32 Screws.....	4
14	9631-403-007	Wire Assembly High Voltage Upper.....	1
15	9627-860-001	Wire Harness Ignition Control Upper.....	I
16	9631-403-006	Wire Assembly High Voltage Lower.....	1
17	9627-860-002	Wire Harness Ignition Control Lower.....	I
*	9053-067-002	Bushing Wire 7/8".....	4
18	9200-001-002	Fuseholder Assembly.....	3
*	8636-018-001	Fuse 1.5 Amp.....	3
19	5192-299-001	Relay Power.....	2
*	9545-045-012	Screws Power #8 AB x 1/2".....	4
*	8220-062-036	Wire Assembly Red/Black 14"	1
*	8220-062-037	Wire Assembly Red/White 14"	1
20	9627-864-001	Wire Harness Motor Extension.....	2
21	9527-007-001	Stand Off - Wire Saddle / Arrowhead	5
22	9627-863-001	Wire Harness Main Extension Access Under Burner Housing.....	1

18
1
18

Control Protection Fuse
 24VAC Ignition Upper Pocket Protection Fuse

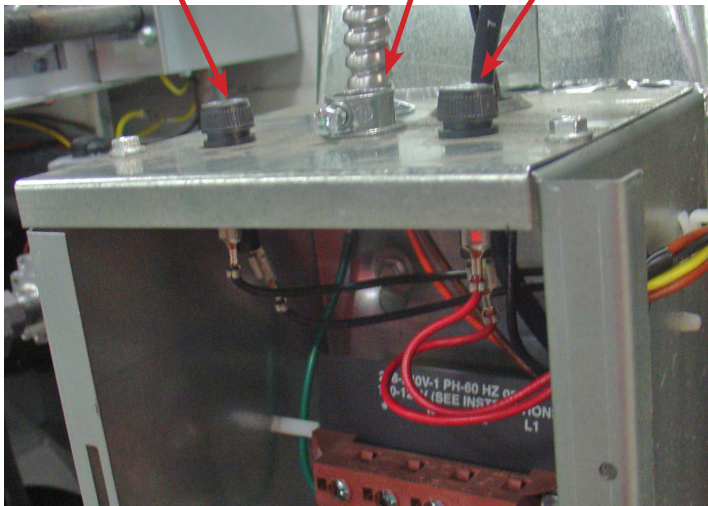

Not Shown:
24VAC Ignition Lower
Pocket Protection
Fuse

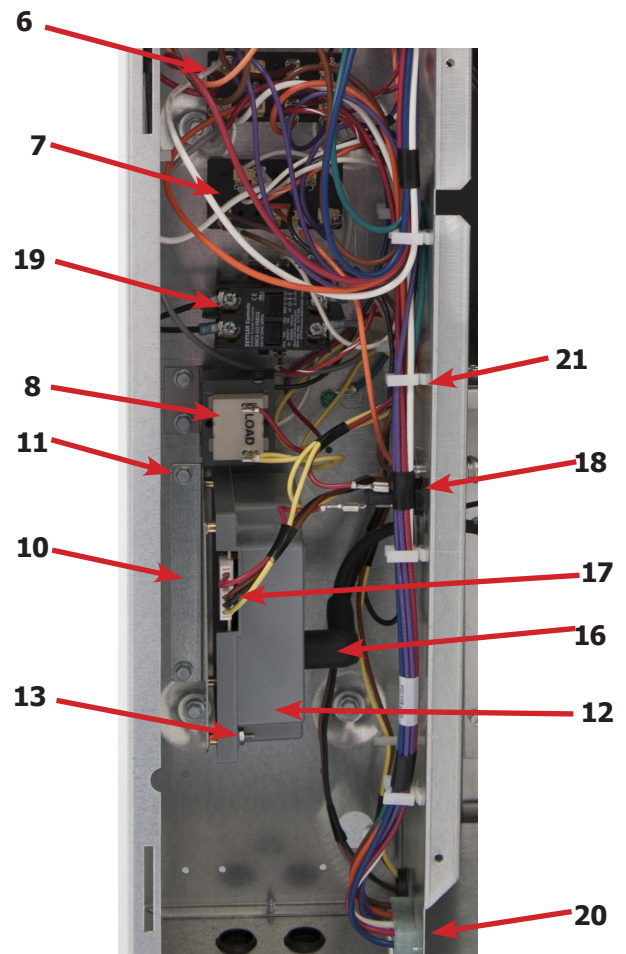
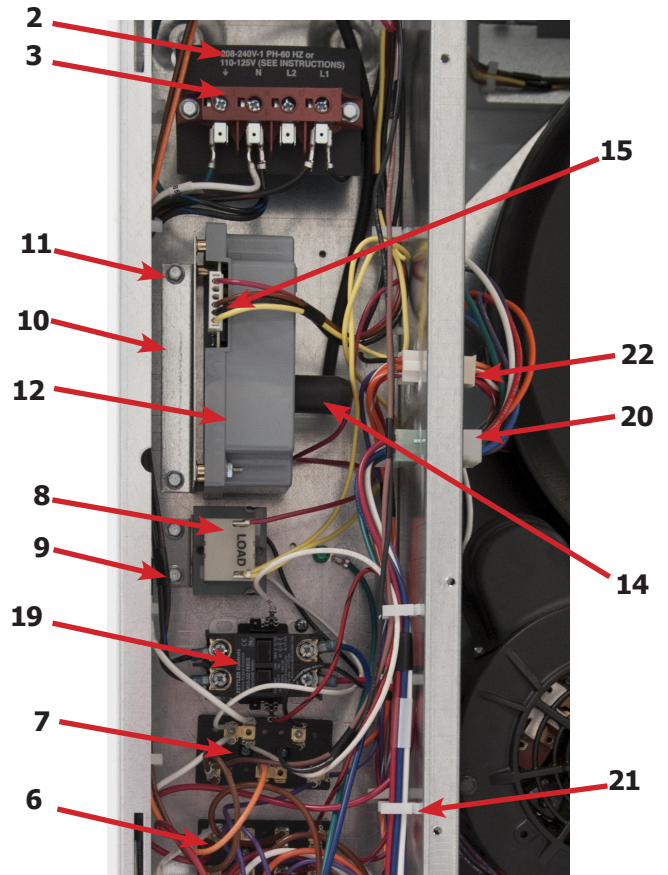
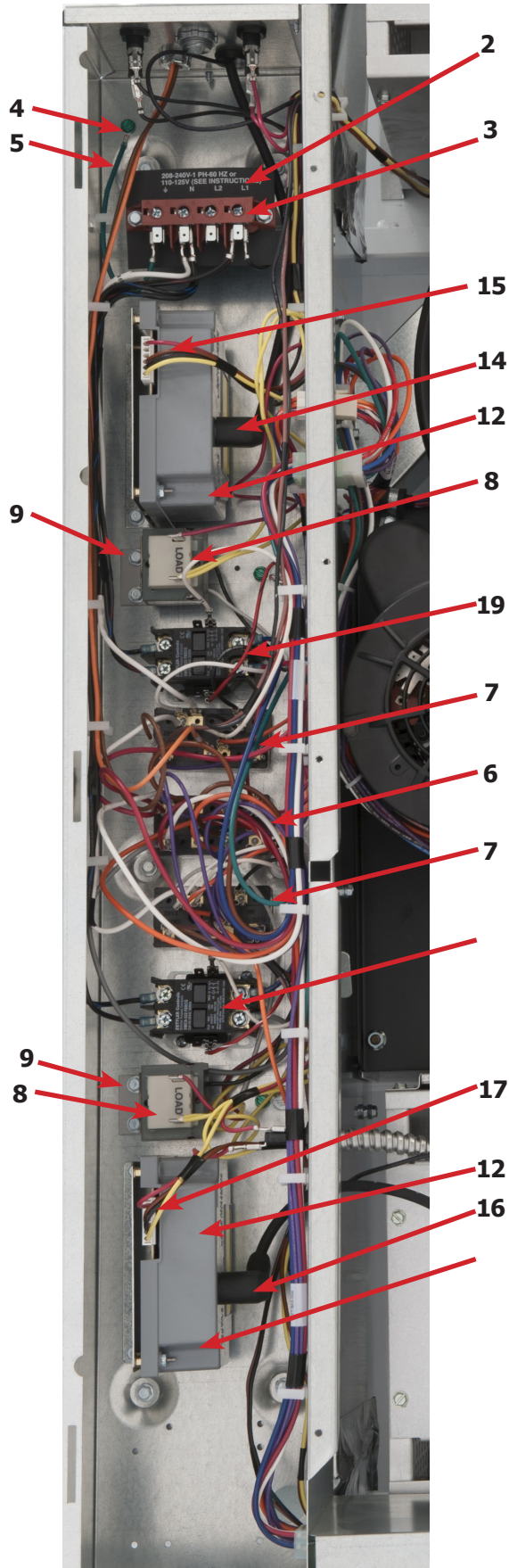

Coin Acceptor

Key	Part Number	Description	Quantity
1	9021-041-001	Coin Acceptor, Optical	1
2	9801-099-001	Sensor-Optical, Replacement.....	1
3	9545-039-002	Screw, Height Bar, 3mm.....	2
*	9486-136-001	Retainer, Coin Acceptor	1
*	9545-053-002	Screw	4

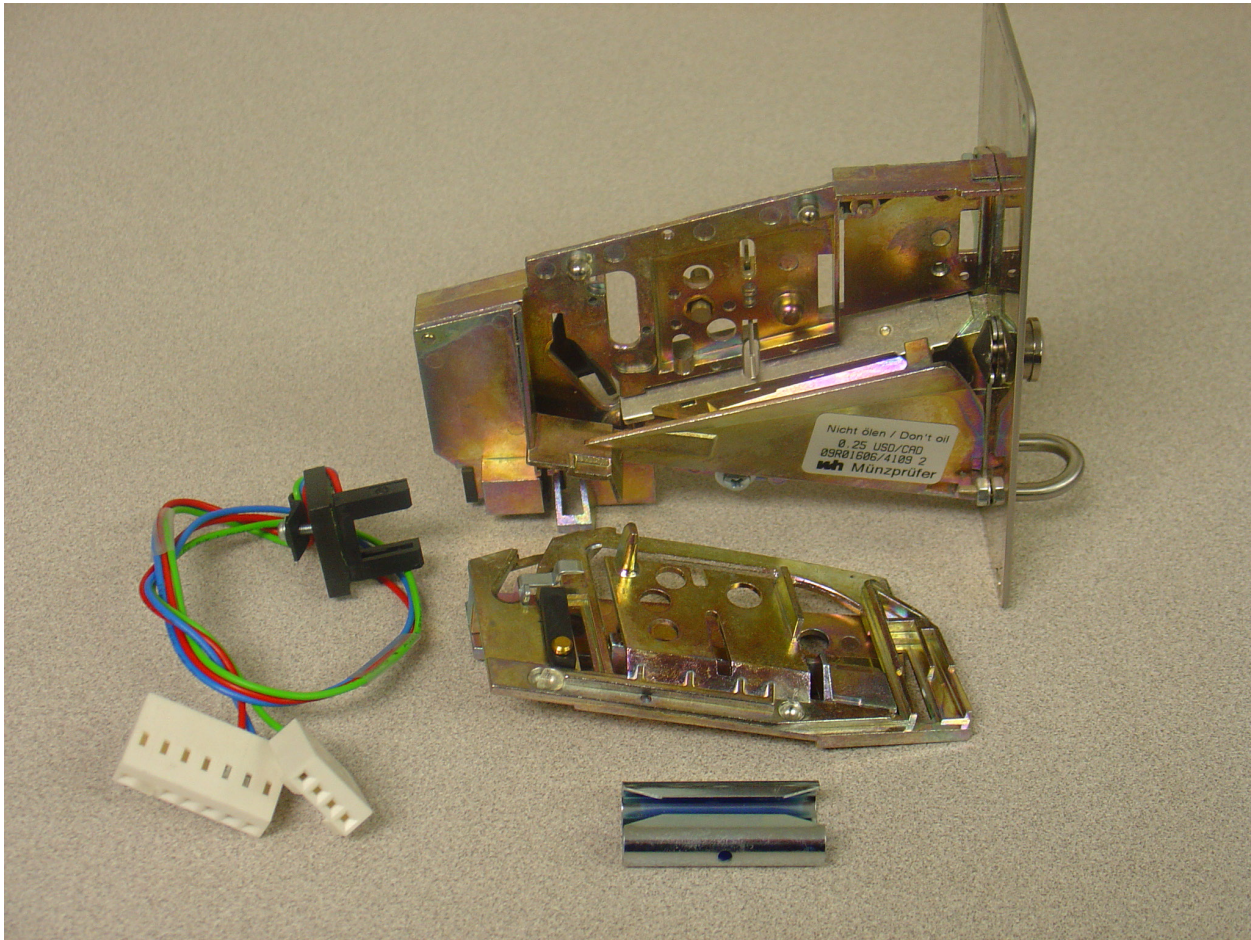

Wiring Group

Key	Part Number	Description	Quantity
*	9627-911-001	Wiring Harness- Main Power	1
*	9631-403-001	Wire, Hi Voltage, Spark 38".....	2
*	8502-645-001	Label Instruction.....	1
*	9506-544-001	Wiring Label Schematic/Diagram	1
*	9627-860-001	Wire Harness Ignition Upper Low Voltage	1
*	9627-860-002	Wire Harness Ignition Lower Low Voltage	1
*	9627-863-001	Wire Harness Main Extension	1
*	9627-864-001	Wire Harness Motor Extention	2
*	8220-062-036	Wire Assembly Red/Black 14".....	1
*	8220-062-037	Wire Assembly Red/White 14"	1
*	8220-062-038	Wire Assembly White 14".....	2
*	9627-861-001	Wire Harness - Overtemp / Airswitch	2
*	9627-862-001	Wire Harness Main Controller w/ Door Switch Wires	1
*	9627-855-003	Wire Harness - Heat Sensor	1
*	8527-112-001	Decal Lighting and Clearance.....	1
*	8502-763-001	Label Warning & Notice	2
*	8502-764-001	Label Warning Dryer, FRN/SPN	2
*	9506-544-001	Schematic /Diagram.....	1
*	8514-233-001	Operators Manual	1
*	8507-365-001	Instructions Convert Dual Voltage	1
*	8507-330-001	Instruction Transient Voltage Suppressor	1
*	8507-350-001	Instructions Dryer Install / Start	1
*	8220-137-001	Wire Assembly Green 24".....	1
*	8220-001-466	Wire Assembly Yellow 4 7/8" Gas Valve	2
*	8220-095-038	Wire Assembly Orange 48".....	2
*	9506-544-001	Wiring Schematic/Diagram	1
*	8220-095-040	Wire Assembly Orange 24".....	1
*	8220-095-041	Wire Assembly Brown 24".....	1
*	9052-067-002	Bushings Wire 7/8".....	4

Wiring Diagram for DC30x2

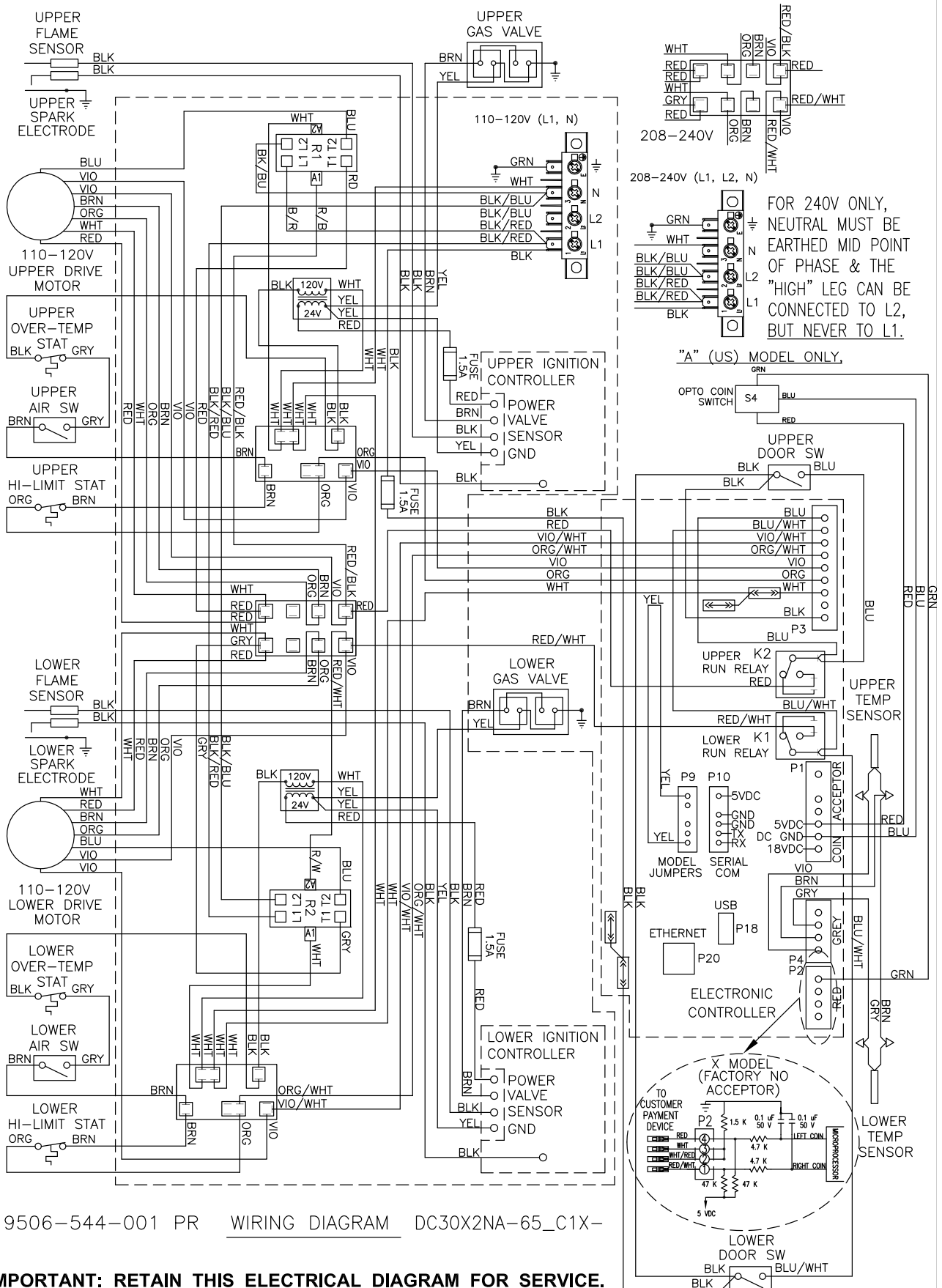

9506-544-001 PR WIRING DIAGRAM DC30X2NA-65_C1X-

IMPORTANT: RETAIN THIS ELECTRICAL DIAGRAM FOR SERVICE.

Wiring Schematic for DC30x2

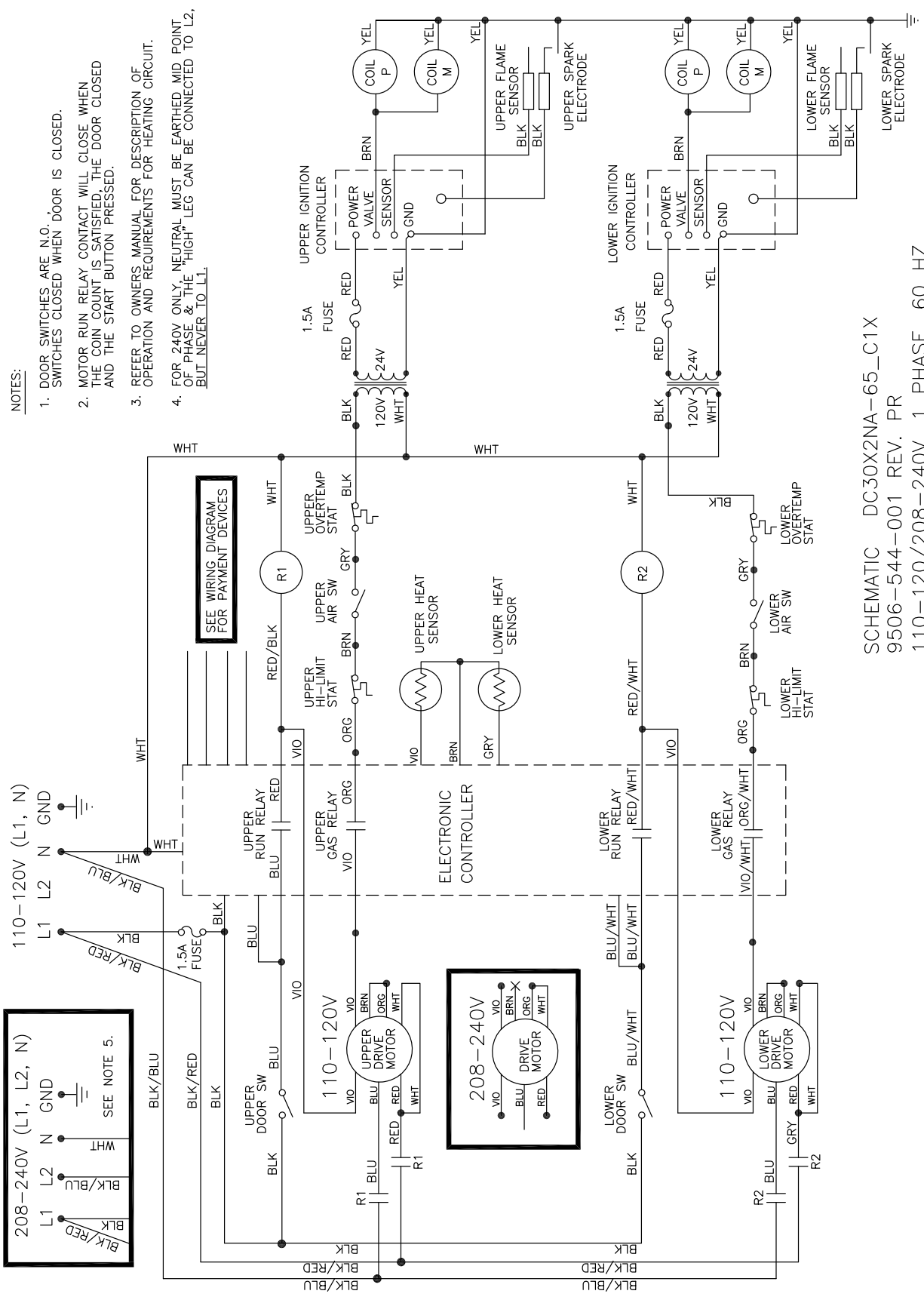

NOTES:

1. DOOR SWITCHES ARE N.O. SWITCHES CLOSED WHEN DOOR IS CLOSED.
2. MOTOR RUN RELAY CONTACT WILL CLOSE WHEN THE COIN COUNT IS SATISFIED, THE DOOR CLOSED AND THE START BUTTON PRESSED.
3. REFER TO OWNERS MANUAL FOR DESCRIPTION OF OPERATION AND REQUIREMENTS FOR HEATING CIRCUIT.
4. FOR 240V ONLY, NEUTRAL MUST BE EARTHED MID POINT OF PHASE & THE "HIGH" LEG CAN BE CONNECTED TO L2, BUT NEVER TO L1.

SCHEMATIC DC30X2NA-65_C1X
 9506-544-001 REV. PR
 110-120/208-240V, 1 PHASE, 60 HZ

IMPORTANT: RETAIN THIS ELECTRICAL SCHEMATIC FOR SERVICE.

Notes

Lined area for taking notes, consisting of numerous horizontal lines.